

# Heating And Hot Water Solutions







The name Joule is synonymous with innovation, quality and performance. These values lie at the heart of a culture that has been developed by listening to the needs and expectations of our customers.

Unvented water heating is the fastest growing sector of the UK market, Joule have been leading this growth as the UK's fastest growing cylinder brand. Unvented systems are fed directly from the cold water mains supply and offer a number of benefits compared to conventional systems. Higher pressure and flow rates at all hot taps, balanced hot and cold water supplies, no special taps required. Manufactured from the highest quality materials.

Joule are at the forefront of developing the UK unvented cylinder market with a complete range of ERP rated cylinders available, We have B-C rated cylinders held as standard stock and the option of A rated cylinders made to your order requirements. The new Smartplumb by Joule is a complete retake on the systemfit market bringing this cutting edge cylinder to every installers hands.

With a deep understanding of the renewable technologies no other UK manufacturer is better positioned to offer the cylinder that is best suited to your renewable project. Why not use the complete package from Joule, from the air source heat pump to the underfloor heating and aluminium radiators no other manufacturer can offer you the complete package under one roof. Designed, manufactured, pre assembled and commissioned from one company with one guarantee.



# Table Of Contents

- 06 Cylinder Selection Guide
- 08 Manufacturing Excellence
- 12 Advantages of KIWA Certificate

## Cyclone Domestic Range

- 14 Cyclone Air Indirect
- 16 Cyclone Air Direct
- 18 Indirect
- 20 Direct
- 22 Twin Solar
- 24 Direct Solar
- 26 Smart Plumb Pre-plumbed Indirect
- 28 Slimline Indirect
- 30 Slimline Direct
- 32 Slimline Twin Solar
- 34 High Gain Indirect
- 36 High Gain Solar
- 38 Slimline High Gain Indirect
- 40 Slimline High Gain Solar
- 42 Horizontal
- 44 Thermal Store 1.0
- 46 Thermal Store 2.0
- 48 Mild Steel Buffer Tanks
- 50 Stainless Steel Buffer Tanks
- 51 Unvented Kit Components
- 52 Samsung Heat Pump
- 54 Smart Plumb Heat Pump
- 56 Aero Direct
- 58 Wellmaster

## InvaHeat Underfloor

- 60 Underfloor Systems
- 61 System Types
- 62 System Components
- 63 Underfloor Controls

## Solar Systems

- 64 Acapella System
- 66 Navitas 2m / 2.5m On-roof System
- 68 Navitas 2m In-roof System

## Commercial Cylinder Range

- 70 Commercial Cylinder Quick Guide
- 71 Immersion Allocation
- 72 Indirect Commercial
- 74 Multi Energy Commercial
- 76 Solar Commercial
- 78 Ordering Guide
- 80 Water Heaters

## Useful Information

- 82 ErP As Easy As 1-2-3
- 83 Generating Package Label
- 84 Installation Guidance
- 85 Specification Summary
- 86 Connecting Units
- 87 Selection Guide







400L	500L	600L	800L	1,000L	1,250L	1,500L	2,000L	3,000L	4,000L	5,000L		
												Indirect
												Direct
												Cyclone Air
												Indirect
												Direct
												Twin Solar
												Direct Solar
												Smart Plumb Indirect
												Slimline Indirect
												Slimline Direct
												Slimline Twin Solar
												High Gain Indirect
												High Gain Solar
												Slimline High Gain Indirect
												Slimline High Gain Solar
												Horizontal Indirect
												Thermal Store 1.0 Standard
												Thermal Store 1.0 Solar
												Thermal Store 2.0 Standard
												Thermal Store 2.0 Solar
												Mild Steel Buffer - No Coil
												Mild Steel Buffer - With Coil
												Stainless Steel Buffer
												Smart Plumb Heat Pump
												Aero Direct Standard
												Aero Direct Solar
												Wellmaster Twin
												Wellmaster Triple
												Indirect 3 / 6 bar
												Multi Energy 3 / 6 bar
												Solar 3 / 6 bar
												SmartTherm

# Manufacturing Excellence

To produce a superior cylinder takes a mixture of knowledge, experience, technology, precision and skill. Joule and its owners have been involved in manufacturing cylinders for more than 30 years and over this time we have seen many developments in the manufacturing processes. We are confident today we operate one of the most advanced production facilities supplying cylinders to the European market including the UK and Ireland.

All Joule cylinders start their life as a roll of stainless steel sheet. For a roll of stainless steel to reach the factory floor it must pass stringent quality control checks at the goods inwards department. No component is taken into stock until it has been fully inspected and tested. Unchecked product sits in a holding area to ensure there is no cross contamination. A sheet used to make the body of the inner and outer shells are de-coiled and punched using a **laser guided punching machine**. The punched sheets are then fed down a conveyer system to the rolling machine where they are rolled to a cylindrical shape with **0.001mm tolerance**.

The punched and rolled sheet is then robotically welded along the seam. This creates the cylindrical shape. After the body has been welded the smooth tube 316L stainless coil is fitted into the punched holes on the body. The coil started its life as a large roll of tubing that is de-coiled and re-coiled into what is required for the specific cylinder. Following this the domes for both the top and bottom are fitted. This is one of the most important processes as the edge of the dome must sit exactly inline with the edge of the body. This ensures that there is no overlap between the two pieces of metal removing any possibility of crevice corrosion. Once the domes have been tacked into place the item is reloaded onto the robotic welder and a circumferential weld is carried out between the domes and the body.

Another differentiating factor with the Joule cylinder is the fact that all connections not just the seam and the dome are robotically welded. This ensures consistency in the weld and reduces the defects. We operate a total quality management system to reduce defects and improve quality so after each process is carried out the work is quality checked at the point. By checking for defects at each stage of the production we can remedy any issue that may occur with the process at an early stage which moves us closer to zero defects.

Unlike most manufacturers we test our cylinders using sensors rather than humans. This ensures that nothing passes through our final testing procedure. The cylinders are then transferred into the after weld treatment baths which pickle and passivate the welds to ensure that they are strong and resistant to corrosion.

Once the cylinders have been treated and cleansed they are now ready for casing. At this stage the cylinder is turned from being horizontal to vertical. The cylinder moved through the entire production process up to this point horizontally. The cylinders are matched up with their unique outer casing and lids.







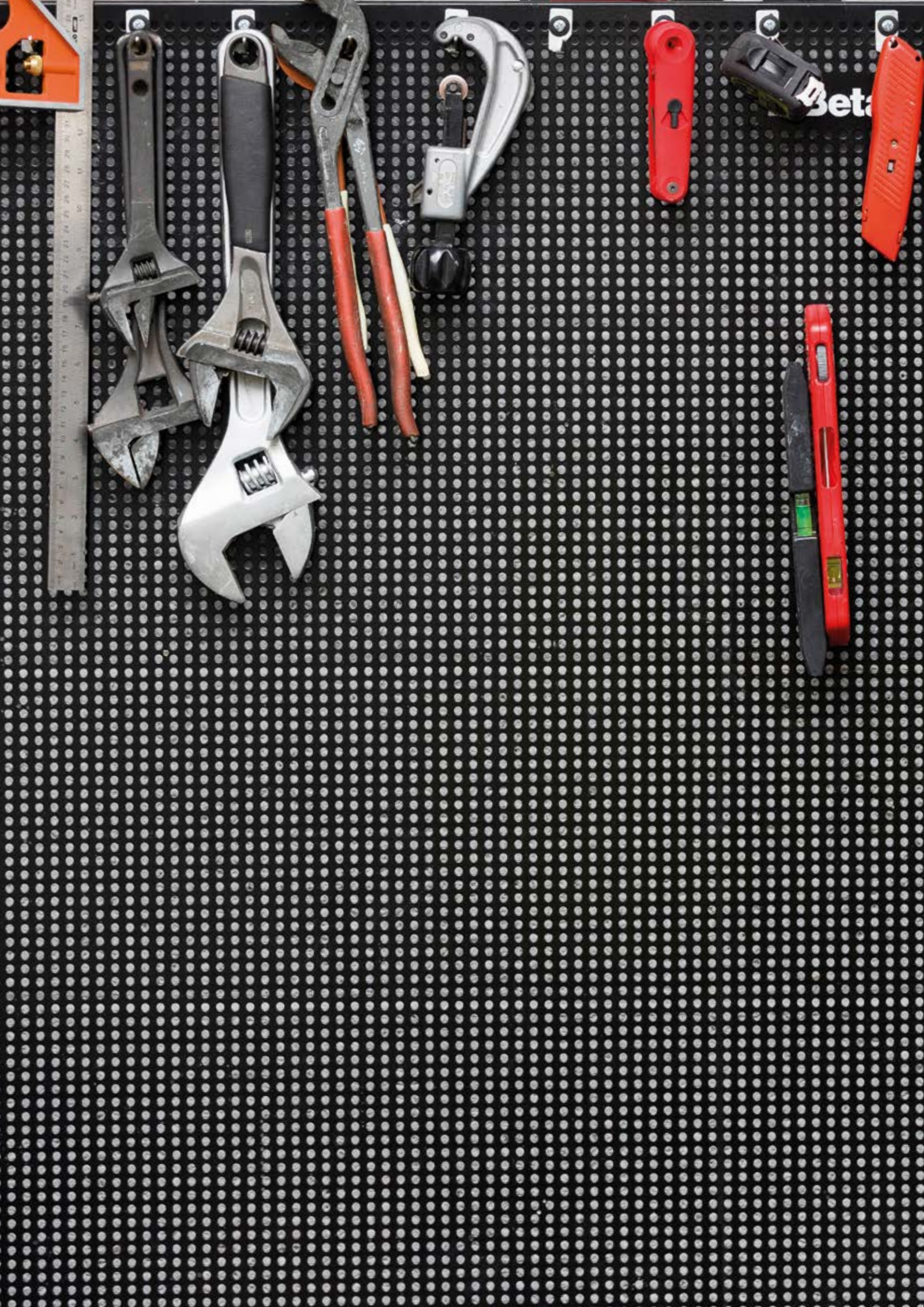



# Manufacturing Excellence

At Joule we believe our cylinders are of superior quality to most other cylinders on the market today. The confidence in our quality is not achieved easily. We have worked tirelessly over the last 8 years developing our product range specification, manufacturing processes and machinery.

Our superior quality starts with our raw materials. By operating a total quality management system we ensure that only raw materials of the highest quality are used in our cylinders.

It sounds simple but a zero dirt policy on the production floor ensure that no foreign debris enters the metal at any stage. We do not use machines for multiple types of metal. Copper cylinders are handled using totally separate machines than stainless ensuring that there is no cross contamination.

Butt welding the entire cylinder separates us from the crowd. We don't just butt weld the seam and the domes we also butt weld the fittings and the coils. Most other manufacturers skip this as it slows down the process. Some don't bother butt welding any part of the cylinder and some do the seam and the domes but few do all the fittings and coils also.

Our coils are what makes us different. Although some other manufacturers would have you believe that the corrugated 0.4mm thick coil is a better coil this is clearly not the case. At Joule we still use 1mm smooth tube coil with longer lengths providing the same surface area as the corrugated coils. This thicker coil ensures a longer life span on your product and because the coil is smooth it emits heat better as it is facing away from itself at all times unlike corrugated coil.

We pickle and passivate all our cylinders. This process treats the metal post welding to ensure that it has it's durable long life coat. This process is not done by all manufacturers and even the ones that do this process do not all take the correct amount of time in submersing the item in the chemical. If the cylinder is only rinsed with the chemical or dipped in and out of a bath of the chemical then it will not have the time needed to work on retreating the metal. At Joule all cylinders are robotically placed in the treatment tank and held there for a programmed time period before being transferred to the next bath.

# Advantages of KIWA Certificate

## Certification

A certificate will enable you to demonstrate that your organisation works efficiently and safely, that you manage your work and work processes and that you strive to be a sustainable business. It allows you to reduce risks and improve the quality of your company, products and employees. An independent third party such as KIWA will ensure that it is going to stay this way.

## Advantages Of Having A KIWA Certificate

KIWA are one of the top 25 global testing, inspection and certification organisations (TICs). They meet the stringent demands of the ISO/IEC 17065 accreditation standard. All of the Joule unvented cylinders have been tested in KIWA's own test laboratories and have been independently verified as satisfying the requirements of all of the required product legislation, regulation and codes of practice applicable to the UK and the Republic of Ireland.

KIWA regularly audit the internal quality control processes of the production facilities of the organisations whose products they have certificated, to ensure that they always meet the set requirements. Joule describe all of the arrangements, procedures, work instructions and inspection moments in an Internal Quality Control Scheme document (IQSC). This IQSC is then linked to the product requirement to produce an Assessment Directive (AD). KIWA will carry out an audit of this AD.

A KIWA certificate will enable you to demonstrate that your organisation is using products that are fully compliant with all Regulations, Legislation and Codes of Practice that are applicable to Unvented Hot Water Cylinders that you install in the UK or Republic of Ireland.





Compliance with Building Regulations, Water Regulations and IEE Regulations is mandatory, so having an independent 3rd party certificate, such as KIWA, to demonstrate conformity, not only satisfies the Building Control officials, but also gives you complete peace of mind.

Certainty for clients – your clients can be sure that you have met the requirements of the mandatory Regulations and Legislation regarding the products you are using

Efficiency – A KIWA certificate confirms that the performance of the products that you are using conform with the requirements of the Building Regulations, Water Regulations and ErP Legislation

Confidence with the Competent Authorities – A KIWA certificate means that you avoid all of the difficult discussions about whether you comply with the latest Regulations and Legislation or not. A certificate will make it much easier to be granted a pass on all aspects of the project.

Market Opportunity – By supporting your tender documents or quotations with a KIWA certificate you have an additional, and very strong selling point. KIWA is a renowned, independent inspection authority that certifies that you are providing quality products that are fit for purpose and fully compliant.

# Indirect

**Cyclone Air**



**New design = outstanding aesthetics**

**High performance coil = faster recovery**

**Cold feed diffuser = more hot water**



**Internal bubble = no more exp. vessel**

**Pre-blanked drain = easy service**

**Pre-plumbed = easy to install**

## System Components



Inlet Control Group



T&P Valve



Tundish



Zone Valve



Cylinder Stat

## Dimensions

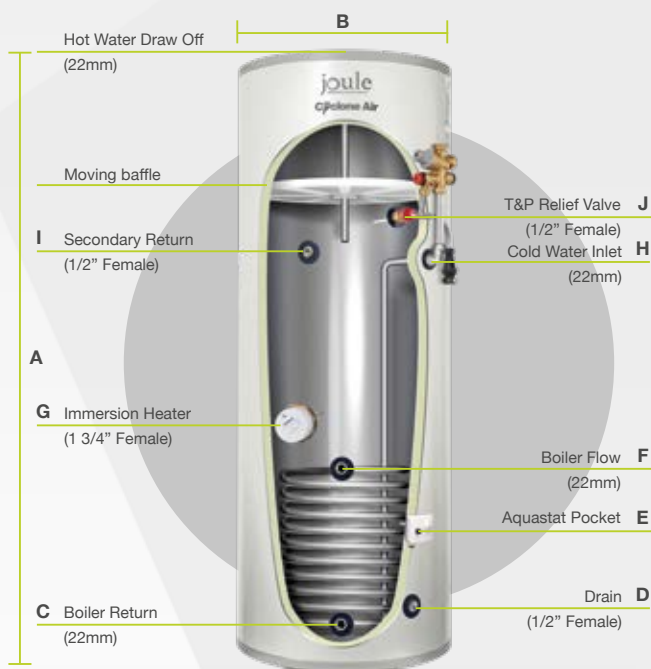

The inlet control group, T&P valve and tundish are pre-plumbed and factory fitted. The zone valve and cylinder stat are supplied unassembled.

## Technical Information

Capacity	120L	150L	180L	210L	250L	300L
Item Code	TCEMVA-0120LFC	TCEMVA-0150LFC	TCEMVA-180LFC	TCEMVA-0210LFC	TCEMVA-0250LFC	TCEMVA-0300LFC
Height (A)	1005	1196	1285	1530	1785	2060
Diameter (B)	540	540	540	540	540	540
Weight (empty)	35	39	43	46	56	65
Weight (full)	158	187	210	243	302	361
Cold Water Capacity	112	139	159	188	236	279
Energy Efficiency Class	B	B	B	C	C	C
Bottom Coil Rating (kW)	20	20	20	21	23	23
Heat up Time - coil (mins)	22	26	30	34	39	46
Reheat Time	13	16	18	21	25	32
Standing Loss (W)	52	55	58	81	89	103

- Slimline versions with 475 mm diameter are also available for capacities 120L - 210L
- Twin coil solar versions are also available for capacities 180L - 300L

## Direct

Cyclone Air



New design = outstanding aesthetics

More insulation = greater economy

Pre-blanked drain = easy service



Internal bubble = no more exp. vessel

Cold feed diffuser = more hot water

Pre-plumbed = easy to install



## System Components



Inlet Control Group



T&amp;P Valve



Tundish

The inlet control group, T&P valve and tundish are pre-plumbed and factory fitted.

## Dimensions

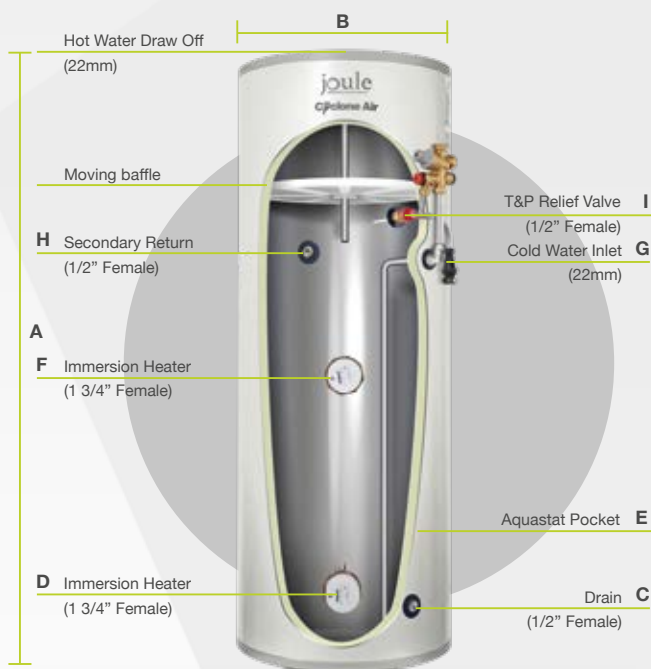

## Technical Information

Capacity	120L	150L	180L	210L	250L	300L
Code	TCEMVB-0120LFC	TCEMVB-0150LFC	TCEMVB-0180LFC	TCEMVB-0210LFC	TCEMVB-0250LFC	TCEMVB-0300LFC
Height (A)	1005	1196	1285	1530	1785	2060
Diameter (B)	540	540	540	540	540	540
Weight (empty)	30	34	37	41	49	55
Weight (full)	155	184	207	241	299	355
Cold Water Capacity	112	139	159	188	236	279
Energy Efficiency Class	C	C	C	C	C	C
Heat up Time - coil (mins)	74	89	101	109	149	179
Reheat Time	46	57	57	81	104	129
Standing Loss (W)	52	55	58	81	89	103
Immersion Heaters (3kW)	2	2	2	2	2	2
Load Profile	L	L	L	L	L	XL
Efficiency (%)	36	38	37	36	36	38

- Slimline versions with 475 mm diameter are also available for capacities 120L - 210L

# Indirect

Cyclone



The Joule range of un-vented cylinders are the UK's fastest growing cylinder brand. Built on quality and performance, with one of the widest ranges of models available you can be sure there is a model to suit. With the introduction of the Energy Related Product certificate scheme under an EU directive, Joule are leading the way by offering a complete range of A, B & C rated cylinders. The same quality you have been accustomed too is now available across all rated cylinders. The Cyclone brand is noted for its attractive grey finish. Noticeably there is no cheap plastic used on the outer casing. Inside only the best materials are used, duplex stainless steel body, 316L grade stainless fittings and coils. Our quality is nowhere better noticed than in the construction of our coils. Unlike most cheaper brands on the market Cyclone range of cylinders use high recovery smooth tube coils for optimal performance. No other coil type on the market today offers the same transfer rate as smooth stainless tube.

- Single high recovery coil
- Smooth tube coil construction for durability and performance
- Compression connections fitted as standard
- Bevelled stat pocket for better fitting
- Metallic grey wipe clean rigid case for premium appearance
- Pre plugged secondary tapping for ease of installation
- All Connections clearly labelled
- Butt Welded process used throughout
- Robotically welded
- Branded quality components

joule

## System Components

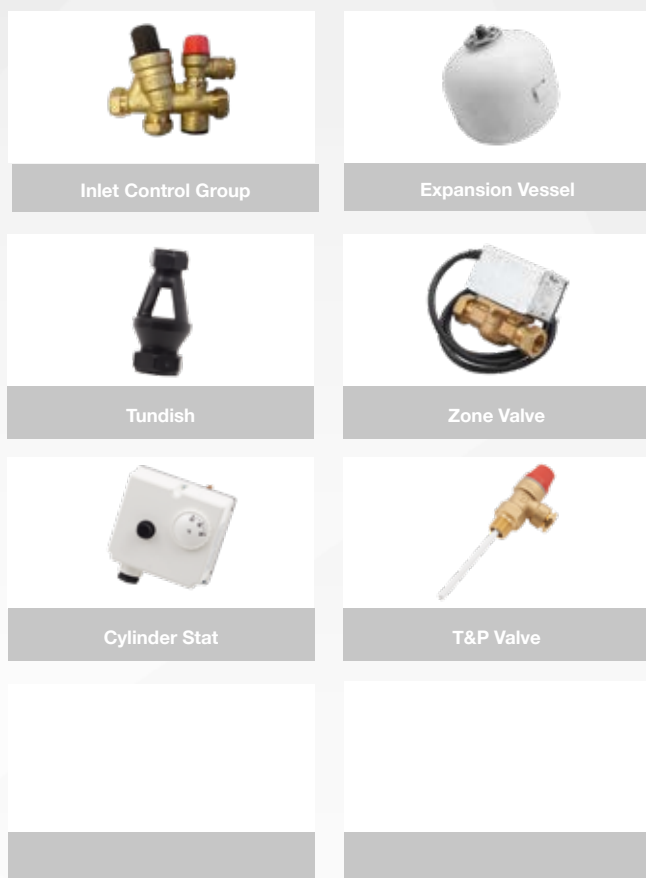

## Dimensions

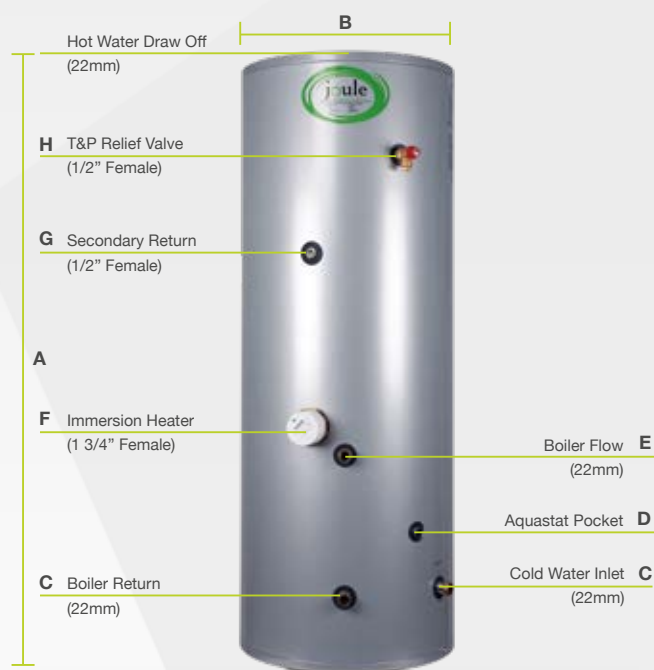

## Indirect

Capacity	90L	125L	150L	170L	200L	200L	250L	250L	300L	300L	400L	500L
Code	TCEMVI-0090LFB	TCEMVI-0125LFB	TCEMVI-0150LFB	TCEMVI-0170LFB	TCEMVI-0200NFC	TCEMVI-0200LFC	TCEMVI-0250NFC	TCEMVI-0250LFC	TCEMVI-0300NFC	TCEMVI-0300LFC	TCEMVI-0400LFC	TCEMVI-0500LFC
Height (A)	950	1030	1190	1310	1150	1490	1400	1815	1600	2040	1570	1900
Diameter (B)	500	540	540	540	600	540	600	540	600	540	710	710
Weight (empty)	39	35	39	43	46	47	56	57	64	65	71	87
Weight (full)	135	158	187	210	243	244	302	303	360	361	471	589
Hot water volume	96	124	148	168	194	196	247	247	290	289	390	494
C	188	196	196	196	218	196	218	196	218	196	225	225
D	333	211	341	341	423	336	383	361	383	361	405	455
E	478	511	486	486	538	516	608	586	608	586	675	745
F	543	651	551	551	603	581	673	651	673	651	740	810
G	628	751	786	881	768	981	968	1271	1153	1551	1180	1440
H	743	80	911	1031	883	1211	1133	1531	1333	1811	1280	1640
Energy Efficiency Class	<b>B</b>	<b>B</b>	<b>B</b>	<b>B</b>	<b>C</b>	<b>C</b>	<b>C</b>	<b>C</b>	<b>C</b>	<b>C</b>	<b>C</b>	<b>C</b>
Heat up Time - coil (Mins)	14	23	26	27	31	31	37	37	42	42	52	54
Standing Loss (W)	44	52	55	58	78	81	87	89	92	103	102	115

# Direct

Cyclone

C



The Joule range of un-vented cylinders are the UK's fastest growing cylinder brand. Built on quality and performance, with one of the widest ranges of models available you can be sure there is a model to suit. With the introduction of the Energy Related Product certificate scheme under an EU directive, Joule are leading the way by offering a complete range of A, B & C rated cylinders. The same quality you have been accustomed too is now available across all rated cylinders. The Cyclone is noted for its attractive grey finish. Noticeably there is no cheap plastic used on the outer casing. Inside only the best materials are used, duplex stainless steel body, 316L grade stainless fittings and incoloy immersions.

- 3kW Incoloy immersions fitted as standard
- Titanium and 6kW immersion options available on request
- Compression connections fitted as standard
- Bevelled stat pocket for better fitting
- Metallic grey wipe clean rigid case for premium appearance
- Pre plugged secondary tapping for ease of installation
- All Connections clearly labelled
- Butt Welded process used throughout
- Robotically welded
- Branded quality components

joule

## System Components

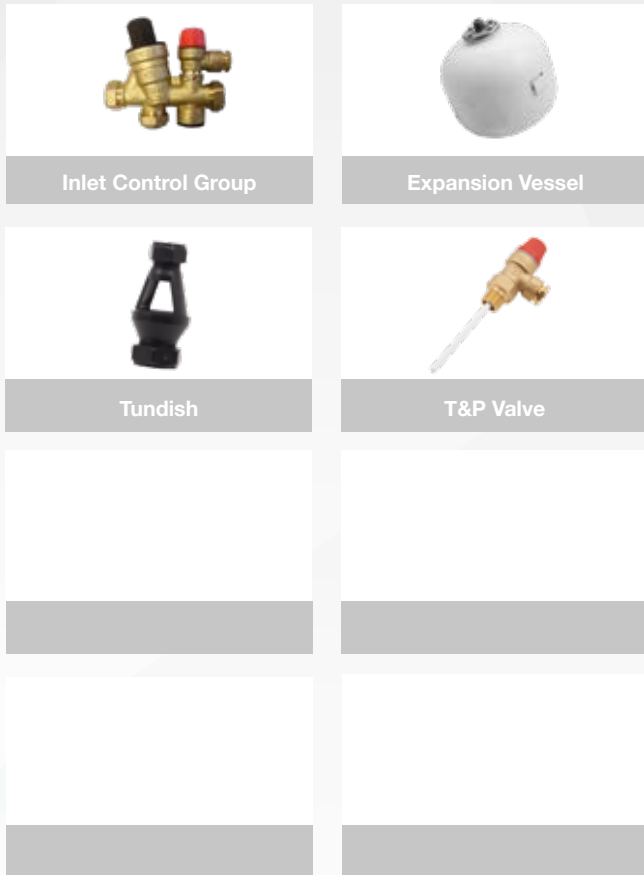

## Dimensions



## Direct

Capacity	90L	125L	150L	170L	200L	200L	250L	250L	300L	300L
Code	TCEMVD-0090LFB	TCEMVD-0125LFB	TCEMVD-0150LFB	TCEMVD-0170LFC	TCEMVD-0200NFC	TCEMVD-0200LFC	TCEMVD-0250NFC	TCEMVD-0250LFC	TCEMVD-0300NFC	TCEMVD-0300LFC
Height (A)	950	1030	1190	1310	1150	1490	1400	1815	1600	2040
Diameter (B)	500	540	540	540	600	540	600	540	600	540
Load profile	L	L	L	L	L	L	L	L	XL	XL
Weight (empty)	36	30	34	37	40	41	49	49	56	55
Weight (full)	135	155	184	207	240	241	299	299	356	355
Hot water volume	99	125	150	170	200	200	250	250	300	300
C	188	196	196	196	218	196	218	196	218	196
D	203	211	211	211	233	211	233	211	233	211
E	468	511	561	631	553	701	653	861	733	1001
F	628	651	786	881	768	981	968	1271	1153	1551
G	743	751	911	1031	883	1211	1133	1531	1333	1811
Energy Efficiency Class	<b>B</b>	<b>B</b>	<b>B</b>	<b>C</b>	<b>C</b>	<b>C</b>	<b>C</b>	<b>C</b>	<b>C</b>	<b>C</b>
Heat up Time - coil (Mins)	52	62	76	96	119	119	140	140	166	166
Energy Efficiency (%)	37	37	37	36	36	35	35	35	37	36
Annual El. Consumption (kWh)	2740	2773	2785	2830	2875	2892	2908	2928	4565	4610
Sound Power Level (dB)	16	16	16	16	16	16	16	16	16	16
Thermostat Temp. Setting (C)	60	60	60	60	60	60	60	60	60	60

# Twin Solar

Cyclone



The Cyclone solar range of cylinders are designed to work with any solar system on the market. Manufactured with 9mm sensor pockets for the solar controller ensures that your solar system performs its best.

- Boiler and Solar high recovery coil
- Smooth tube coil construction for durability and performance
- Compression connections fitted as standard
- Bevelled stat pocket for better fitting
- 9mm Solar stat pockets for PT1000 solar probes
- Metallic grey wipe clean rigid case for premium appearance
- Pre plugged secondary tapping for ease of installation
- All Connections clearly labelled
- Butt Welded process used throughout
- Robotically welded
- Branded quality components

joule

## System Components

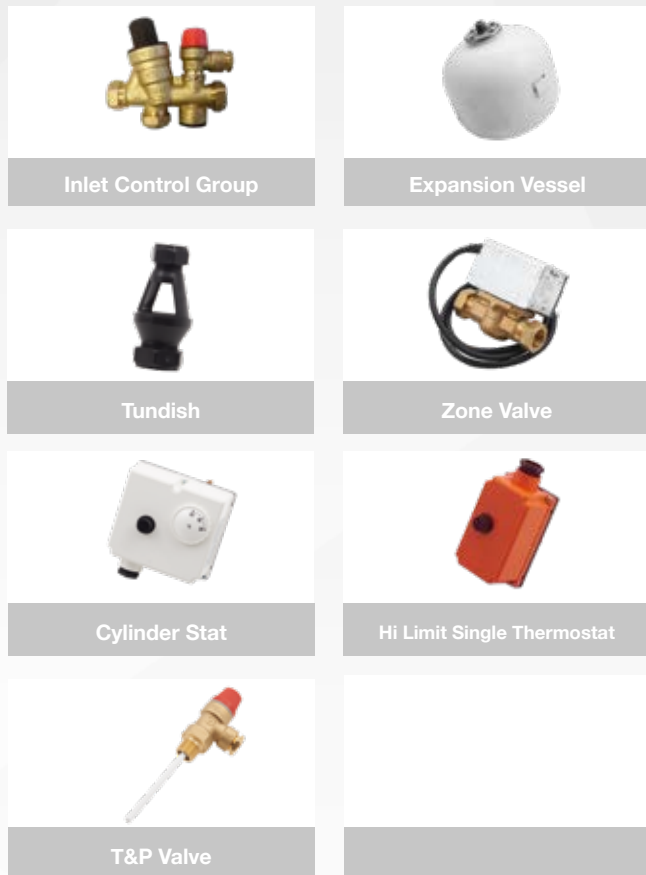

## Dimensions

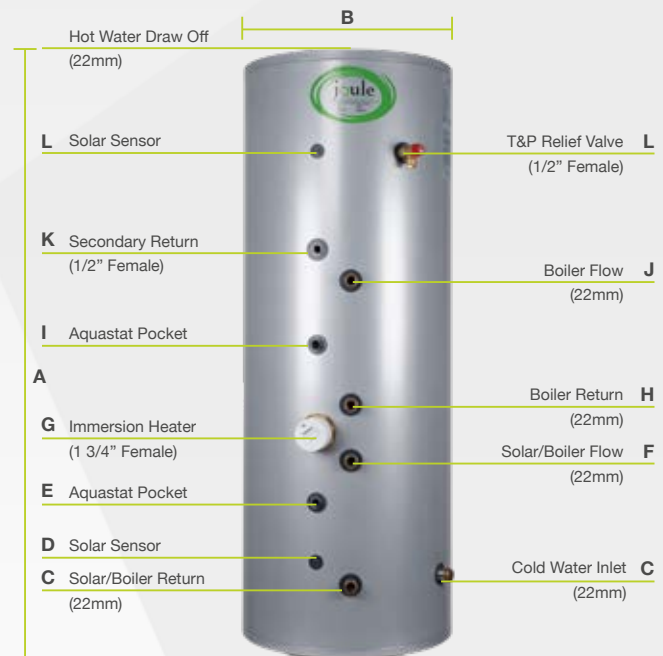

## Twin Solar

Capacity	100L	125L	150L	170L	200L	200L	250L	250L	300L	300L	400L	500L
Code	-	-	-	TCEMVS-0170LFB	TCEMVS-0200NFC	TCEMVS-0200LFC	TCEMVS-0250NFC	TCEMVS-0250LFC	TCEMVS-0300NFC	-	TCEMVS-0400LFC	TCEMVS-0500LFC
Height (A)	-	-	-	1310	1150	1490	1400	1815	1600	-	1570	1900
Diameter (B)	-	-	-	540	600	540	600	540	600	-	710	710
Weight (empty)	-	-	-	49	50	50	59	60	67	-	74	87
Weight (full)	-	-	-	219	246	247	307	308	364	-	476	589
Hot water volume	-	-	-	170	196	197	248	248	297	-	402	502
C	-	-	-	196	218	196	218	196	218	-	225	225
D	-	-	-	246	268	246	268	246	268	-	275	275
E	-	-	-	346	368	386	438	416	438	-	430	430
F	-	-	-	446	468	486	538	516	538	-	615	615
G	-	-	-	511	533	551	603	581	603	-	680	680
H	-	-	-	576	598	616	668	646	668	-	745	745
I	-	-	-	681	688	756	798	786	810	-	888	888
J	-	-	-	826	768	906	1053	1031	1053	-	1130	1130
K	-	-	-	882	848	981	968	1271	1153	-	1180	1440
L	-	-	-	1031	883	1211	1133	1531	1333	-	1280	1640
Energy Efficiency Class	-	-	-	<b>B</b>	<b>C</b>	<b>C</b>	<b>C</b>	<b>C</b>	<b>C</b>	-	<b>C</b>	<b>C</b>
Boiler Coil Surface (m <sup>2</sup> )	-	-	-	0.58	0.58	0.58	0.67	0.67	0.67	-	0.77	0.77
kW Rating	-	-	-	16	16	16	18	18	18	-	22	22
Solar Coil Surface (m <sup>2</sup> )	-	-	-	0.58	0.67	0.67	0.77	0.77	0.77	-	1.15	1.28
kW Rating	-	-	-	16	18	18	22	22	22	-	30	16
Heat up Time - coil (Mins)	-	-	-	15	21	21	27	27	32	-	42	49
Standing Loss (W)	-	-	-	58	80	83	89	91	96	-	102	115

## Direct Solar

Cyclone

C



- Water heater powered by solar thermal and electrical elements.
- Available in capacities from 100 to 3,000 litres
- Available with different immersion sizes, material construction and power outputs
- Can be manufactured to customer specifications
- Secondary return connection comes pre-blanked saving on installation time
- Available with a range of insulation thicknesses reducing standing heat losses
- Manufactured from superior grade stainless steel
- Finished with elegant metallic steel outer casing adding to its premium appearance and durability

joule



## System Components



Inlet Control Group



Expansion Vessel



Tundish



Zone Valve



T&P Valve



Hi Limit Single Thermostat

## Dimensions

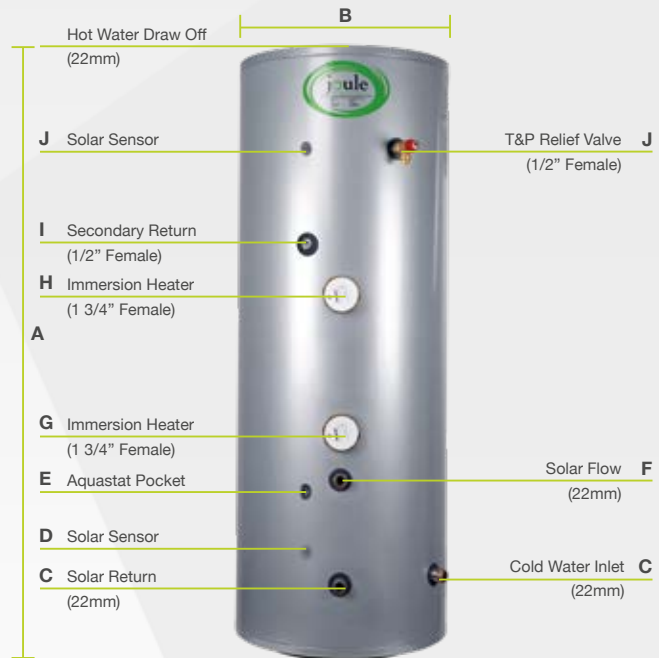

## Direct Solar

Capacity	100L	125L	150L	170L	200L	200L	250L	250L	300L	300L	400L	500L
Code	-	-	TCIMVE-0150LFD	TCIMVE-0170LFD	TCIMVE-0200NFD	TCIMVE-0200LFD	TCIMVE-0250NFD	TCIMVE-0250LFD	TCIMVE-0300NFD	-	TCIMVE-0400LFD	TCIMVE-0500LFD
Height (A)	-	-	1395	1555	1150	1490	1400	1815	1600	-	1570	1900
Diameter (B)	-	-	540	540	600	540	600	540	600	-	710	710
Weight (empty)	-	-	39	43	46	47	56	57	64	-	71	87
Weight (full)	-	-	187	210	243	244	302	303	360	-	471	589
Hot water volume	-	-	148	167	197	197	246	246	296	-	400	502
C	-	-	196	196	218	196	218	196	218	-	225	225
D	-	-	246	246	268	246	268	246	268	-	275	275
E	-	-	346	346	368	386	438	416	438	-	430	430
F	-	-	446	446	468	486	538	516	538	-	615	615
G	-	-	511	511	533	551	603	581	603	-	680	680
H	-	-	636	731	668	821	833	931	968	-	915	1150
I	-	-	762	882	768	981	968	1271	1153	-	1190	1440
J	-	-	911	1031	883	1211	1133	1531	1333	-	1290	1640
Energy Efficiency Class	-	-	C	C	C	C	C	C	C	-	C	C
Heat up Time - coil (Mins)	-	-	23	24	28	28	34	34	39	-	48	54
Solar Coil Surface (m <sup>2</sup> )	-	-	0.58	0.58	0.67	0.67	0.77	0.77	0.77	-	1.15	1.28
kW Rating	-	-	16	16	18	18	22	22	22	-	30	35
Standing Loss (W)	-	-	55	66	78	81	89	89	92	-	102	115

# Smart Plumb Pre-plumbed Indirect



Smart Plumb by Joule is the next generation in pre plumbed hot water solutions. With its sleek design the space required for a complete system installation has been reduced dramatically. With much shorter installation times required to fit the product compared with that of a standard hot water cylinder. Only using brand leading components such as Honeywell and Reliance you can be assured of the quality of the complete package.









## For System Boiler

- Pre-plumbed for system boiler
- Does not include pump, heating vessel and robo kit
- Includes time clock and dial thermostats
- Includes standard un-vented kit
- Includes heating zone valves (1 or 2)
- Includes by-pass valve
- Includes filling loop
- Includes wiring center

## For Heat Only Boiler

- Pre-plumbed for heat only boiler
- Includes pump, heating vessel and robo kit
- Includes time clock and dial thermostats
- Includes standard un-vented kit
- Includes heating zone valves (1 or 2)
- Includes by-pass valve
- Includes filling loop
- Includes wiring center

## System Components

	
Unvented Kit for Indirect	Heating Expansion Vessel
	
Filling Loop Hose	Wiring Junction Box
	
Joule Dial Type Thermostat	Automatic Air Vent
	
Timeclock	A Rated Circulation Pump

## Dimensions

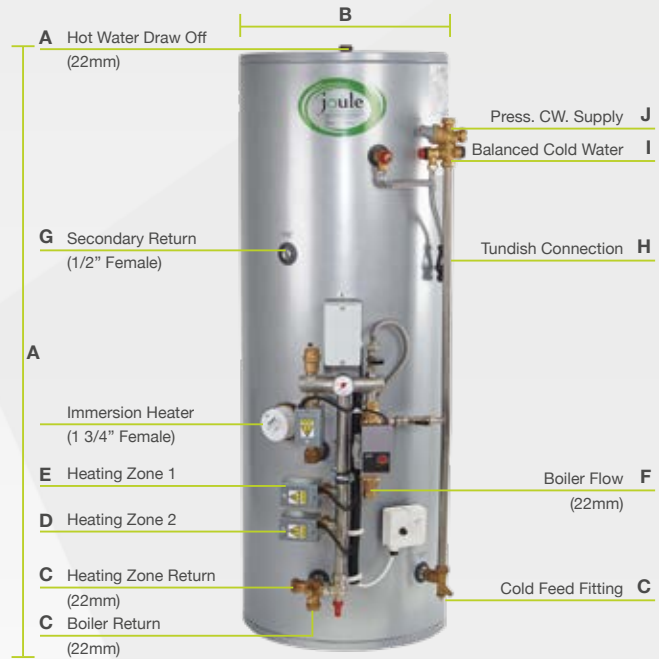

## Footprint Diagram

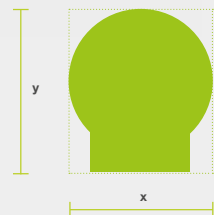

## Smart Plumb Pre-plumbed

Capacity	100L	125L	150L	170L	200L	200L	250L	250L	300L	300L	400L	500L
Height (A)	-	-	1190	1310	-	1490	-	1815	-	2040	-	-
Diameter (B)	-	-	540	540	-	540	-	540	-	540	-	-
Weight (empty)	-	-	51	55	-	59	-	69	-	77	-	-
Weight (full)	-	-	199	222	-	256	-	315	-	373	-	-
Hot water volume	-	-	148	168	-	196	-	247	-	289	-	-
C	-	-	196	196	-	196	-	196	-	196	-	-
D	-	-	286	286	-	316	-	386	-	386	-	-
E	-	-	386	386	-	416	-	486	-	486	-	-
F	-	-	380	380	-	410	-	480	-	480	-	-
G	-	-	786	881	-	981	-	1271	-	1551	-	-
H	-	-	691	810	-	991	-	1311	-	1591	-	-
I	-	-	1100	1220	-	1400	-	1725	-	1950	-	-
J	-	-	1140	1260	-	1440	-	1765	-	1990	-	-
x	-	-	570	570	-	570	-	570	-	570	-	-
y	-	-	680	680	-	680	-	680	-	680	-	-
Energy Efficiency Class	-	-	<b>B</b>	<b>B</b>	-	<b>C</b>	-	<b>C</b>	-	<b>C</b>	-	-
Standing Loss (W)	-	-	55	58	-	81	-	89	-	103	-	-

## Slimline Indirect

Cyclone

C



The Joule range of un-vented cylinders are the UK's fastest growing cylinder brand. Built on quality and performance, with one of the widest ranges of models available you can be sure there is a model to suit. With the introduction of the Energy Related Product certificate scheme under an EU directive, Joule are leading the way by offering a complete range of A, B & C rated cylinders. The same quality you have been accustomed too is now available across all rated cylinders. The Cyclone brand is noted for its attractive grey finish. Noticeably there is no cheap plastic used on the outer casing. Inside only the best materials are used, duplex stainless steel body, 316L grade stainless fittings and coils. Our quality is nowhere better noticed than in the construction of our coils. Unlike most cheaper brands on the market Cyclone range of cylinders use high recovery smooth tube coils for optimal performance. No other coil type on the market today offers the same transfer rate as smooth stainless tube.

- Single high recovery coil
- Smooth tube coil construction for durability and performance
- Compression connections fitted as standard
- Bevelled stat pocket for better fitting
- Metallic grey wipe clean rigid case for premium appearance
- Pre plugged secondary tapping for ease of installation
- All Connections clearly labelled
- Butt Welded process used throughout
- Robotically welded
- Branded quality components

joule

## System Components

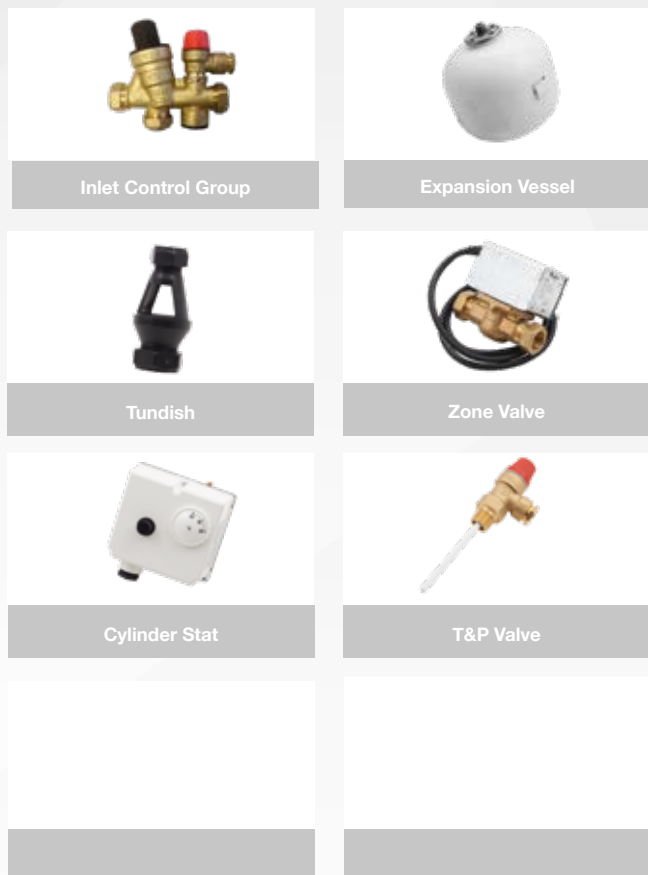

## Dimensions



## Slimline Indirect

Capacity	100L	125L	150L	170L	200L
Code	TCEMVI-0100SFC	TCEMVI-0125SFC	TCEMVI-0150SFC	TCEMVI-0175SFC	TCEMVI-0200SFC
Height (A)	950	1085	1335	1535	1880
Diameter (B)	475	475	475	475	475
Weight (empty)	25	30	39	44	46
Weight (full)	109	137	187	212	241
Hot water volume	84	117	148	168	195
C	191	191	191	191	191
D	311	336	336	384	351
E	481	481	481	576	511
F	546	546	546	641	576
G	631	761	1001	1151	1351
H	746	901	1151	1301	1601
Energy Efficiency Class	C	C	C	C	C
Heat up Time - coil (Mins)	13	23	26	27	31
Standing Loss (W)	56	65	70	79	84

## Slimline Direct

Cyclone



The Joule range of un-vented cylinders are the UK's fastest growing cylinder brand. Built on quality and performance, with one of the widest ranges of models available you can be sure there is a model to suit. With the introduction of the Energy Related Product certificate scheme under an EU directive, Joule are leading the way by offering a complete range of A, B & C rated cylinders. The same quality you have been accustomed too is now available across all rated cylinders. The Cyclone is noted for its attractive grey finish. Noticeably there is no cheap plastic used on the outer casing. Inside only the best materials are used, duplex stainless steel body, 316L grade stainless fittings and incoloy immersions.

- 3kW Incoloy immersions fitted as standard
- Titanium and 6kW immersion options available on request
- Compression connections fitted as standard
- Bevelled stat pocket for better fitting
- Metallic grey wipe clean rigid case for premium appearance
- Pre plugged secondary tapping for ease of installation
- All Connections clearly labelled
- Butt Welded process used throughout
- Robotically welded
- Branded quality components

joule

## System Components

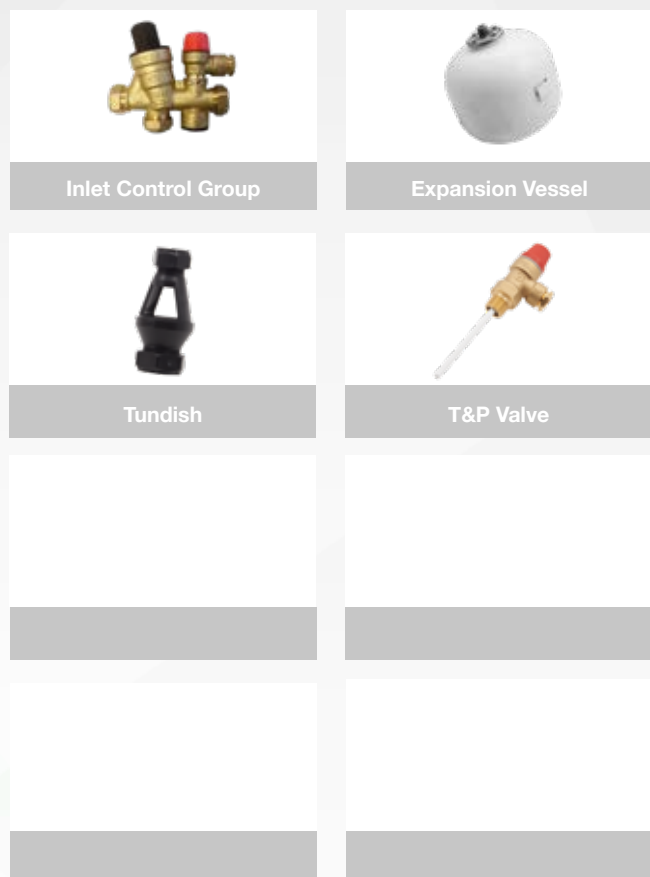

## Dimensions



## Slimline Direct

Capacity	100L	125L	150L	170L	200L
Code	TCEMVD-0100SFB	TCEMVD-0125SFB	TCEMVD-0150SFB	TCEMVD-0170SFC	TCEMVD-0200SFC
Height (A)	950	1085	1335	1535	1880
Diameter (B)	475	475	475	475	475
Load profile	M	L	L	L	L
Weight (empty)	32	30	34	38	40
Weight (full)	125	150	184	208	245
Hot Water Volume	93	120	150	170	205
C	191	191	191	191	191
D	206	206	206	206	206
E	471	506	576	771	896
F	631	761	1001	1151	1351
G	746	901	1151	1301	1601
Energy Efficiency Class	B	B	B	C	C
Heat up Time - coil (Mins)	52	62	76	96	119
Energy Efficiency (%)	34	36	36	36	35
Annual EI. Consumption (kWh)	1513	2826	2846	2883	2904
Sound Power Level (dB)	16	16	16	16	16
Thermostat Temp. Setting (C)	60	60	60	60	60

## Slimline Twin Solar

Cyclone

C



The Cyclone solar range of cylinders are designed to work with any solar system on the market. Manufactured with 9mm sensor pockets for the solar controller ensures that your solar system performs its best.

- Boiler and Solar high recovery coil
- Smooth tube coil construction for durability and performance
- Compression connections fitted as standard
- Bevelled stat pocket for better fitting
- 9mm Solar stat pockets for PT1000 solar probes
- Metallic grey wipe clean rigid case for premium appearance
- Pre plugged secondary tapping for ease of installation
- All Connections clearly labelled
- Butt Welded process used throughout
- Robotically welded
- Branded quality components

joule



## System Components

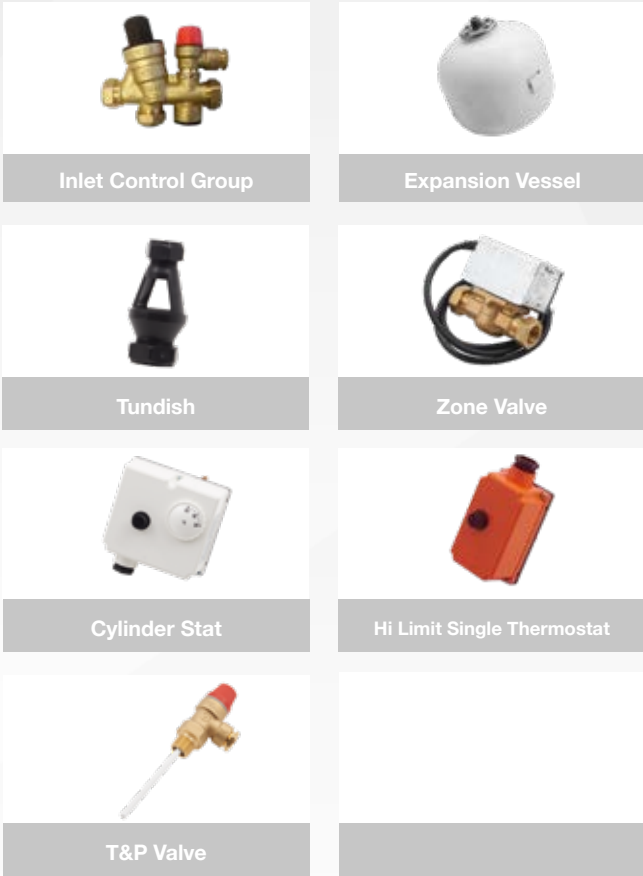

## Dimensions

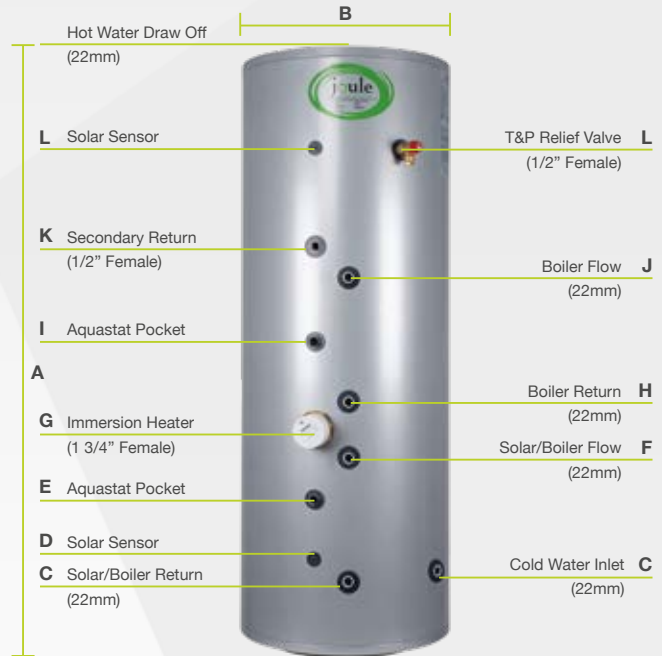

## Slimline Twin Solar

Capacity	170L	200L
Code	TCEMVS-0170SFC	TCEMVS-0200SFC
Height (A)	1535	1880
Diameter (B)	475	475
Weight (empty)	49	50
Weight (full)	214	242
Hot water volume	165	192
C	191	191
D	241	241
E	476	476
F	576	576
G	641	641
H	706	706
I	826	826
J	996	996
K	1151	1351
L	1301	1601
Energy Efficiency Class	C	C
Heat up Time - coil (Mins)	15	21
Standing Loss (W)	79	84

## High Gain Indirect

Cyclone

C



For Heat Pump ready cylinders our coil quality sets us apart. Unlike most cheaper brands on the market Cyclone High Gain range of cylinders use high recovery smooth tube coils for optimal performance. No other coil type on the market today offers the same transfer rate as smooth stainless tube.

- Single high recovery coil in coil
- Smooth tube coil construction for durability and performance
- 1" female coil connections fitted as standard
- Bevelled stat pocket for better fitting
- Metallic grey wipe clean rigid case for premium appearance
- All Connections clearly labelled
- Butt Welded process used throughout
- Robotically welded
- Branded quality components

joule

## System Components

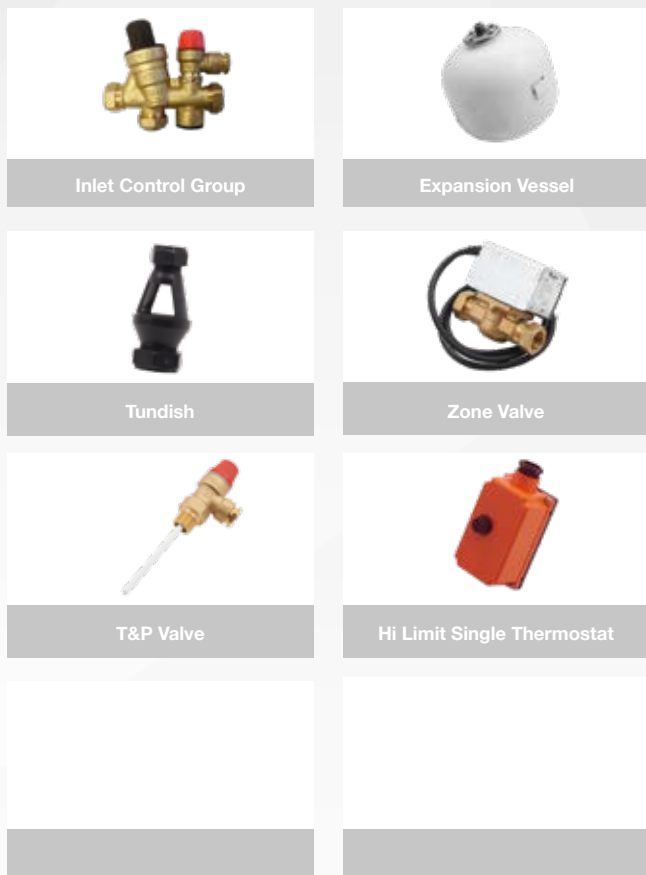

## Dimensions

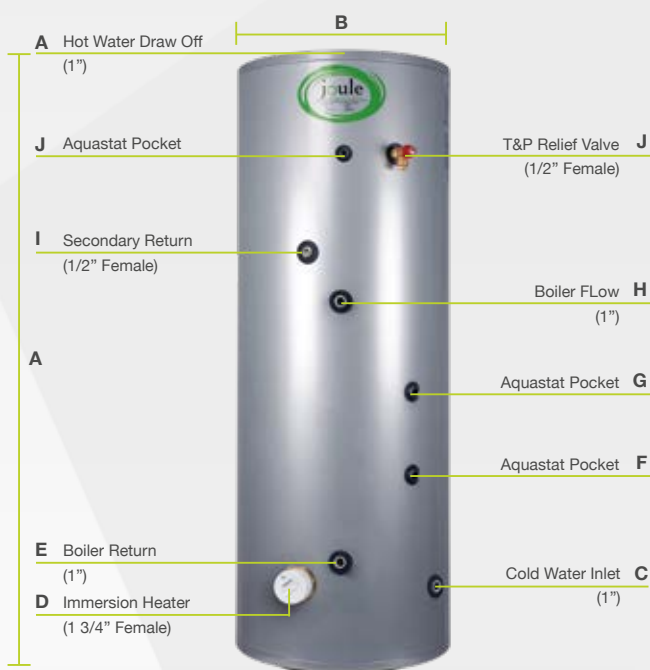

## High Gain Indirect

Capacity	100L	125L	150L	170L	200L	200L	250L	250L	300L	300L	400L	500L
Code	-	-	TCIMVH-0150NFB	TCIMVH-0170NFB	TCIMVH-0200NFC	TCIMVH-0200LFC	TCIMVH-0250NFC	TCIMVH-0250LFC	TCIMVH-0300NFC	TCIMVH-0300LFC	TCIMVH-0400LFC	TCIMVH-0500LFC
Height (A)	-	-	1190	1310	1150	1490	1400	1815	1600	2040	1570	1900
Diameter (B)	-	-	540	540	600	540	600	540	600	540	710	710
Weight (empty)	-	-	46	54	57	58	66	67	74	75	81	107
Weight (full)	-	-	196	223	255	256	315	316	372	373	478	605
Hot water volume	-	-	140	160	187	189	237	236	282	282	378	494
C	-	-	196	196	218	196	218	196	218	196	225	225
D	-	-	211	211	233	211	233	211	233	211	240	240
E	-	-	261	261	283	261	283	261	283	261	290	290
F	-	-	376	406	433	451	483	561	508	586	540	540
G	-	-	571	611	603	701	698	861	773	1022	805	910
H	-	-	861	861	793	911	893	1011	983	1112	1190	1190
I	-	-	786	881	763	981	968	1271	1153	1552	1190	1440
J	-	-	911	1031	883	1211	1133	1531	1333	1812	1290	1640
Energy Efficiency Class	-	-	C	C	C	C	C	C	C	D	C	C
Standing Loss (W)	-	-	55	66	78	81	87	89	92	103	102	115
Heat Up Time (mins)	-	-	10	10	11	11	14	14	17	17	19	22
Coil Surface Size (m <sup>2</sup> )	-	-	2.2	2.2	2.8	2.8	2.8	2.8	3.2	3.2	4.0	4.0

Heat up times are based on using gas or oil boiler and would not be achieved by using lower temperature Heat Pump.

# High Gain Solar

Cyclone



For Heat Pump ready cylinders our coil quality sets us apart. Unlike most cheaper brands on the market Cyclone High Gain range of cylinders use high recovery smooth tube coils for optimal performance. No other coil type on the market today offers the same transfer rate as smooth stainless tube.

- Twin high recovery coil in coil
- Smooth tube coil construction for durability and performance
- 1" female coil connections fitted as standard
- Bevelled stat pocket for better fitting
- Metallic grey wipe clean rigid case for premium appearance
- All Connections clearly labelled
- Butt Welded process used throughout
- Robotically welded
- Branded quality components

joule

## System Components

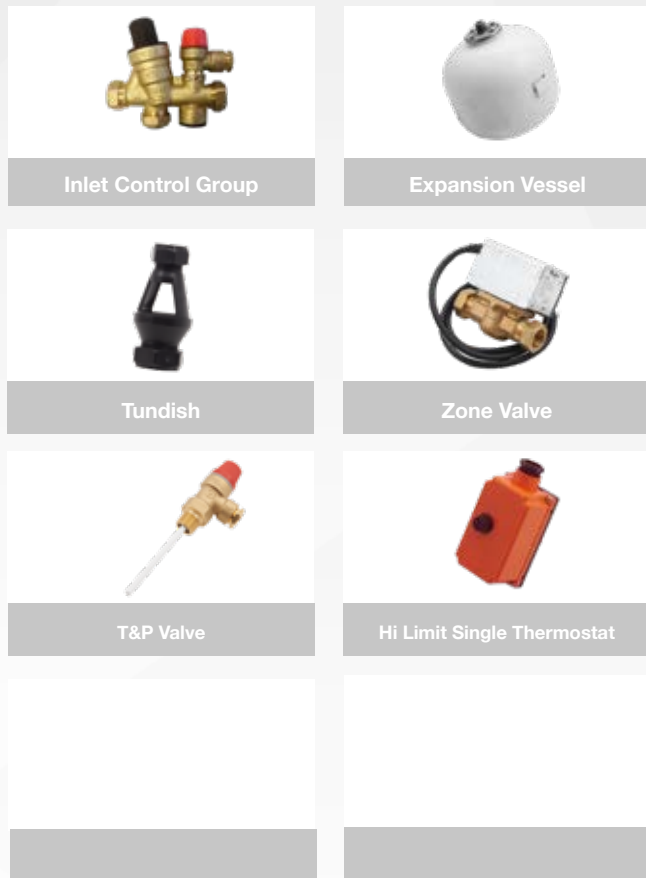

## Dimensions

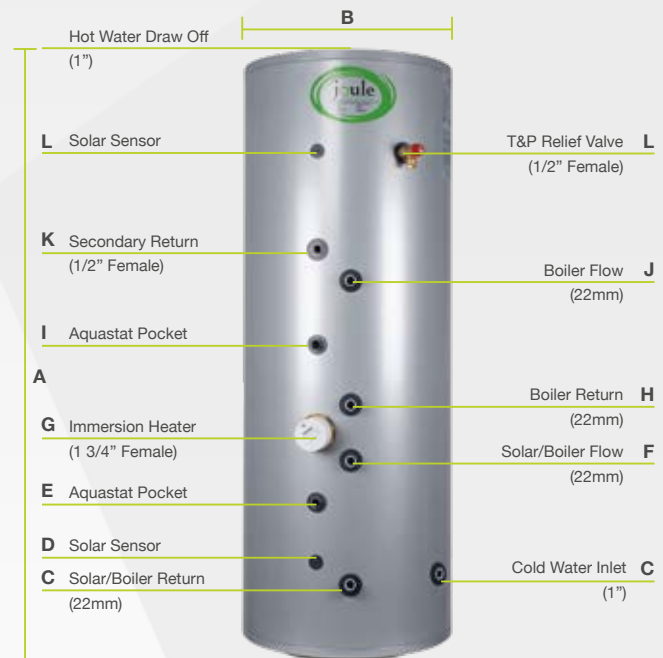

## High Gain Solar

Capacity	100L	125L	150L	170L	200L	200L	250L	250L	300L	300L	400L	500L
Code	-	-	-	-	-	TCIMVG-0200LFC	TCIMVG-0250NFC	TCIMVG-0250LFC	TCIMVG-0300LFC	-	TCIMVG-0400LFC	TCIMVG-0500LFC
Height (A)	-	-	-	-	-	1490	1400	1815	1600	-	1570	1900
Diameter (B)	-	-	-	-	-	540	600	540	600	-	710	710
Weight (empty)	-	-	-	-	-	61	69	70	77	-	84	107
Weight (full)	-	-	-	-	-	258	317	318	374	-	486	609
Hot water volume	-	-	-	-	-	186	240	240	277	-	381	479
C	-	-	-	-	-	196	218	196	218	-	225	225
D	-	-	-	-	-	246	268	246	268	-	275	275
E	-	-	-	-	-	386	388	406	438	-	375	430
F	-	-	-	-	-	486	468	516	538	-	415	615
G	-	-	-	-	-	536	518	606	578	-	465	675
H	-	-	-	-	-	586	568	576	628	-	515	735
I	-	-	-	-	-	791	808	921	813	-	950	950
J	-	-	-	-	-	981	968	1271	1153	-	1190	1440
K	-	-	-	-	-	1136	1118	1376	1328	-	1285	1635
L	-	-	-	-	-	1211	1133	1531	1333	-	1290	1640
Energy Efficiency Class	-	-	-	-	-	C	C	C	C	-	C	C
Heat up Time - coil (Mins)	-	-	-	-	-	21	27	27	32	-	42	49
Hi Gain Coil Surface (m <sup>2</sup> )	-	-	-	-	-	2.8	2.8	2.8	3.2	-	4.0	4.0
Solar Coil Surface (m <sup>2</sup> )	-	-	-	-	-	0.67	0.77	0.77	0.77	-	1.15	1.28
kW Rating	-	-	-	-	-	18	22	22	22	-	30	35

## Slimline High Gain Indirect

Cyclone

C



For Heat Pump ready cylinders our coil quality sets us apart. Unlike most cheaper brands on the market Cyclone High Gain range of cylinders use high recovery smooth tube coils for optimal performance. No other coil type on the market today offers the same transfer rate as smooth stainless tube.

- Single high recovery coil in coil
- Smooth tube coil construction for durability and performance
- 1" female coil connections fitted as standard
- Bevelled stat pocket for better fitting
- Metallic grey wipe clean rigid case for premium appearance
- All Connections clearly labelled
- Butt Welded process used throughout
- Robotically welded
- Branded quality components

joule

## System Components



## Dimensions

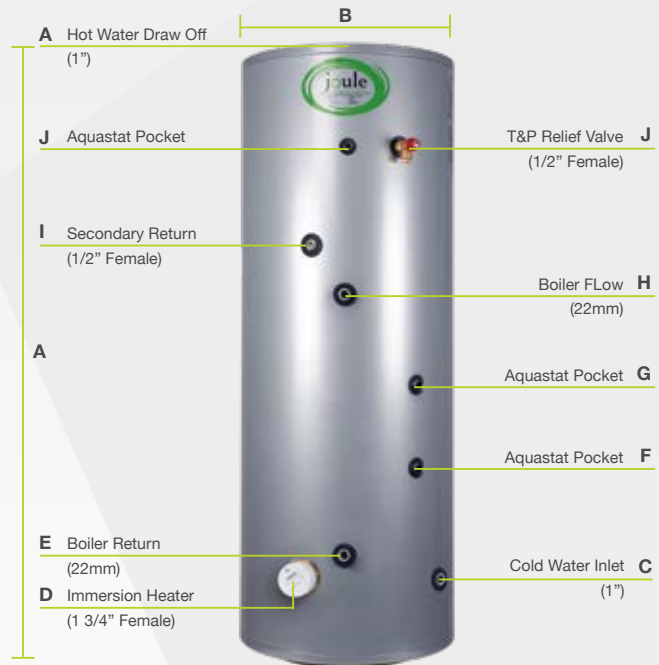

## High Gain Indirect

Capacity	100L	125L	150L	170L	200L	200L	250L	250L	300L	300L	400L	500L
Code	-	-	TCIMVH-0150SFB	TCIMVH-0170SFB	TCIMVH-0200SFC	-	-	-	-	-	-	-
Height (A)	-	-	1335	1535	1880	-	-	-	-	-	-	-
Diameter (B)	-	-	475	475	475	-	-	-	-	-	-	-
Weight (empty)	-	-	35	39	43	-	-	-	-	-	-	-
Weight (full)	-	-	175	199	230	-	-	-	-	-	-	-
Hot water volume	-	-	140	160	187	-	-	-	-	-	-	-
C	-	-	191	191	191	-	-	-	-	-	-	-
D	-	-	206	206	206	-	-	-	-	-	-	-
E	-	-	256	256	256	-	-	-	-	-	-	-
F	-	-	431	466	466	-	-	-	-	-	-	-
G	-	-	706	796	796	-	-	-	-	-	-	-
H	-	-	976	1006	1006	-	-	-	-	-	-	-
I	-	-	1001	1151	1351	-	-	-	-	-	-	-
J	-	-	1151	1301	1601	-	-	-	-	-	-	-
Energy Efficiency Class	-	-	C	C	C	-	-	-	-	-	-	-
Coil Surface Area (m <sup>2</sup> )	-	-	2.2	2.5	2.8	-	-	-	-	-	-	-
Standing Loss (W)	-	-	70	79	84	-	-	-	-	-	-	-
Heat Up Time (mins)	-	-	26	27	31	-	-	-	-	-	-	-

## Slimline High Gain Solar

Cyclone

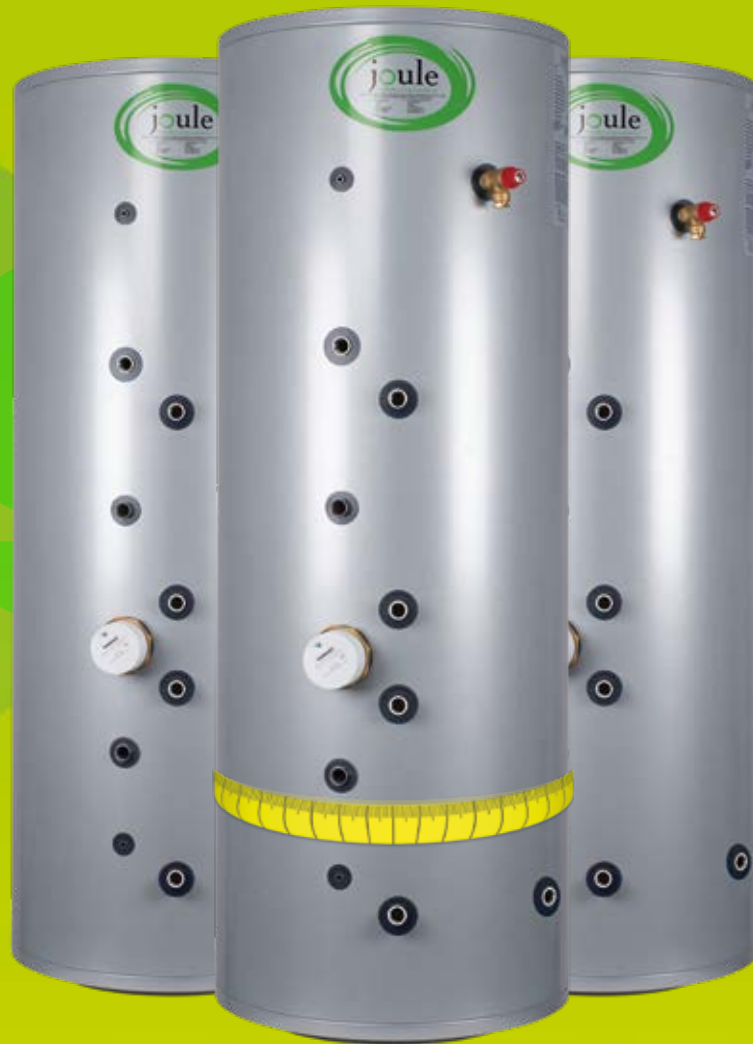

For Heat Pump ready cylinders our coil quality sets us apart. Unlike most cheaper brands on the market Cyclone High Gain range of cylinders use high recovery smooth tube coils for optimal performance. No other coil type on the market today offers the same transfer rate as smooth stainless tube.

- Twin high recovery coil in coil
- Smooth tube coil construction for durability and performance
- 1" female coil connections fitted as standard
- Bevelled stat pocket for better fitting
- Metallic grey wipe clean rigid case for premium appearance
- All Connections clearly labelled
- Butt Welded process used throughout
- Robotically welded
- Branded quality components

joule



## System Components

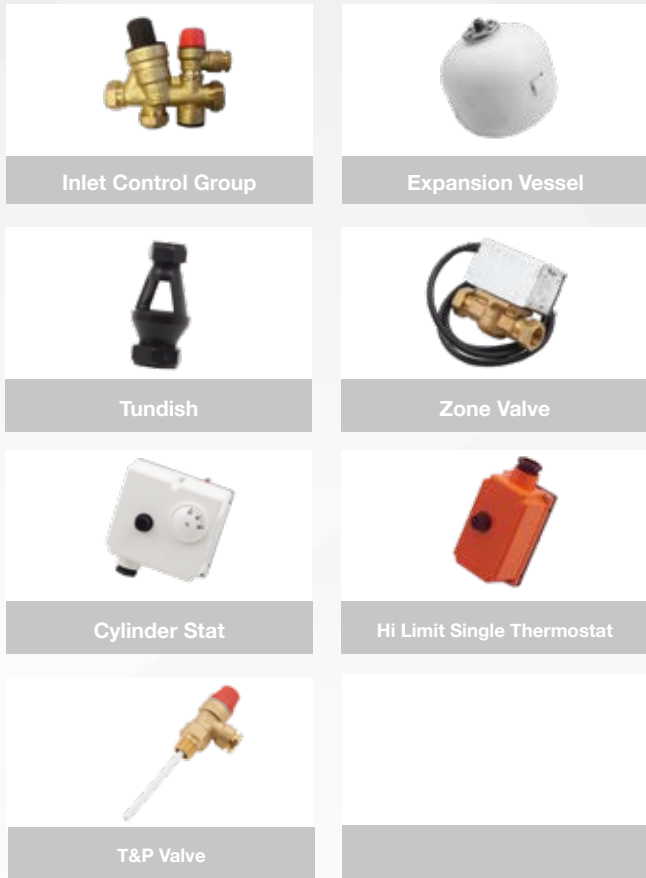

## Dimensions

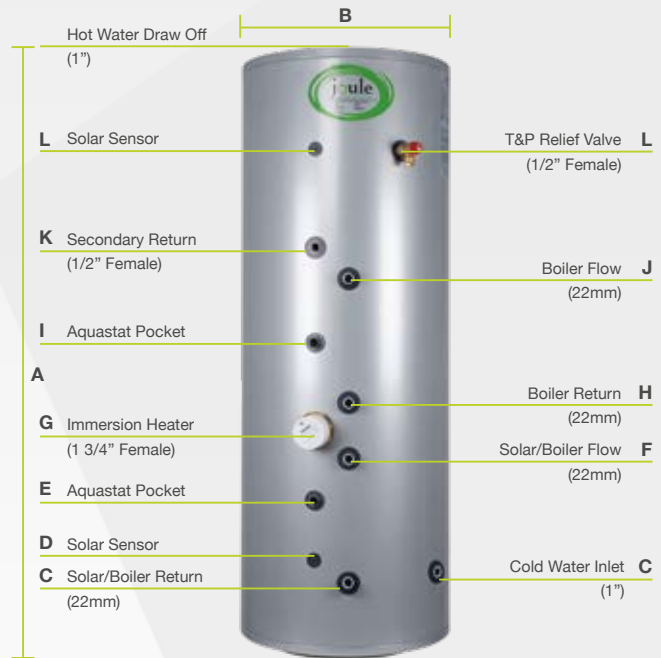

## High Gain Solar

Capacity	100L	125L	175L	200L	200L	250L	250L	300L	300L	400L	500L
Code	-	-	TCIMVG-0170SFC	TCIMVG-0200SFC	-	-	-	-	-	-	-
Height (A)	-	-	1535	1880	-	-	-	-	-	-	-
Diameter (B)	-	-	475	475	-	-	-	-	-	-	-
Weight (empty)	-	-	45	46	-	-	-	-	-	-	-
Weight (full)	-	-	202	230	-	-	-	-	-	-	-
Hot water volume	-	-	157	184	-	-	-	-	-	-	-
C	-	-	191	191	-	-	-	-	-	-	-
D	-	-	241	241	-	-	-	-	-	-	-
E	-	-	381	396	-	-	-	-	-	-	-
F	-	-	481	576	-	-	-	-	-	-	-
G	-	-	531	626	-	-	-	-	-	-	-
H	-	-	581	676	-	-	-	-	-	-	-
I	-	-	871	996	-	-	-	-	-	-	-
J	-	-	1151	1351	-	-	-	-	-	-	-
K	-	-	1241	1476	-	-	-	-	-	-	-
L	-	-	1301	1601	-	-	-	-	-	-	-
Energy Efficiency Class	-	-	C	C	-	-	-	-	-	-	-
Heat up Time - coil (Mins)	-	-	15	21	-	-	-	-	-	-	-
Hi Gain Coil Surface (m <sup>2</sup> )	-	-	2.5	2.8	-	-	-	-	-	-	-
Solar Coil Surface (m <sup>2</sup> )	-	-	0.58	0.58	-	-	-	-	-	-	-
Standing Loss (W)	-	-	79	84	-	-	-	-	-	-	-

## Horizontal



Our Horizontal range of cylinders are come with cradles not only included but pre fitted. They can be easily removed if you need to squeeze the cylinder through a tight access hatch.

- Comes complete with cradles fitted
- Solar coil option available
- Female connections throughout
- Smooth tube rigid coil means no air locking
- Bevelled stat pocket for better fitting
- Metallic grey wipe clean rigid case for premium appearance
- Butt Welded process used throughout
- Robotically welded
- Branded quality components
- Multiple system schematics available in installation manual

## System Components



## Dimensions

### Front

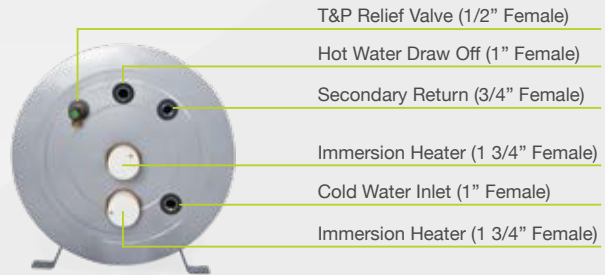

### Back

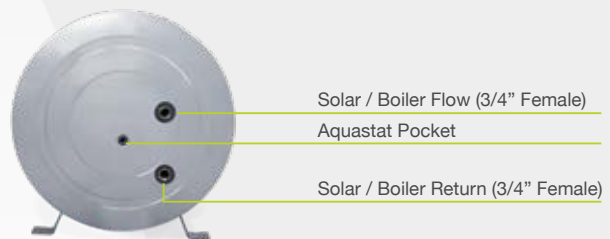

## Horizontal Indirect

Capacity	150L	170L	200L	250L	300L	400L	500L
Code	TCIMHI-0150LFB	TCIMHI-0170LFC	TCIMHI-0200NFC	TCIMHI-0250NFC	TCIMHI-0300NFC	TCIMHI-0400LFC	TCIMHI-0500LFC
Length (A)	1140	1205	1085	1335	1535	1535	1880
Diameter (B)	540	540	600	600	600	710	710
Weight (empty)	39	43	46	56	64	71	87
Weight (full)	187	210	243	302	360	471	589
Hot water volume	148	168	194	247	97	400	502
Load profile							
Energy Efficiency Class	C	C	C	C	C	C	C
Energy Efficiency %							
Annual El. Consumption (kWh)							
Sound Power Level (dB)							
Thermostat Temp. Setting (°C)							
Heat up Time - coil (Mins)	26	27	31	37	42		
Standing Loss (W)	63	69	89	97	104	112	125

## Thermal Store 1.0

Cyclone

C



The Joule Cyclone Thermal Store 1.0 is the ideal solution for multi energy applications. The hot water is produced through an internal coil. The internal coil is a simple and straight forward solution. It will not achieve the higher flow rates which the 2.0 can achieve. The internal coil cannot be serviced or maintained unlike the 2.0.

- 3kW Incoloy immersions fitted as standard
- Solar coil option available
- Female connections throughout
- Bevelled stat pocket for better fitting
- Metallic grey wipe clean rigid case for premium appearance
- Ideal multi energy tank solution
- 1" direct connections
- Butt Welded process used throughout
- Robotically welded
- Branded quality components

joule

## Dimensions

### Thermal Store 1.0 Standard

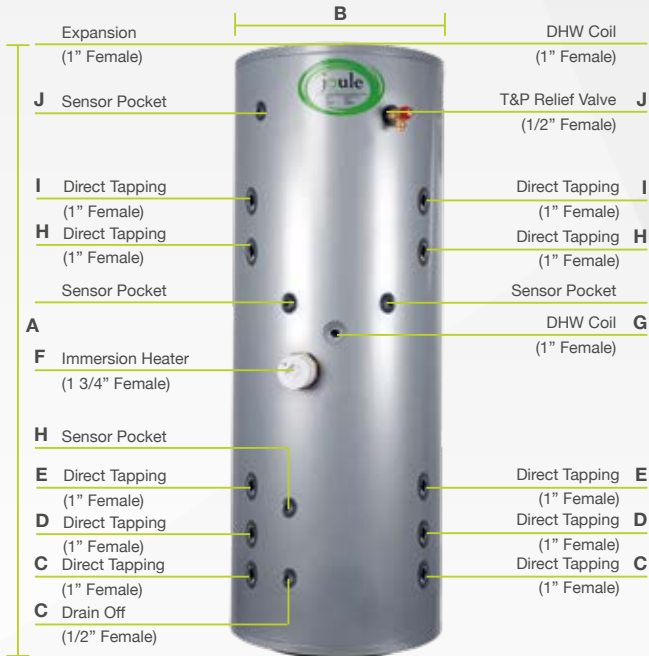

### Thermal Store 1.0 Solar

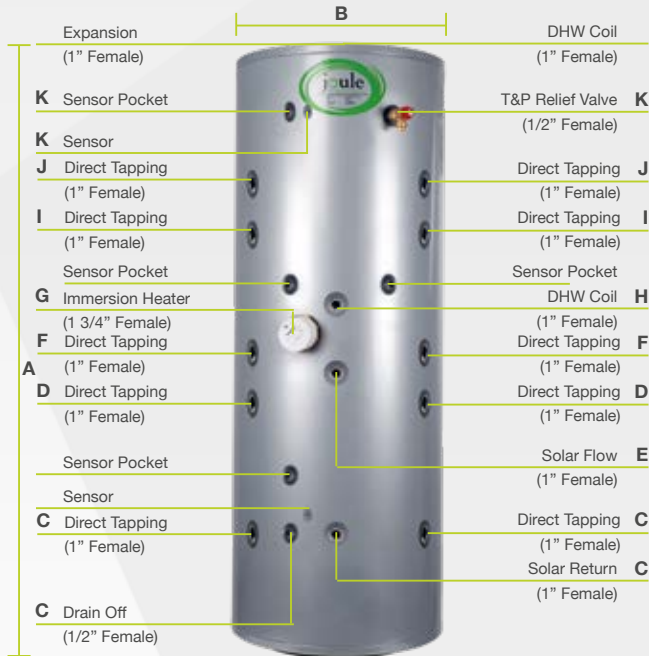

## Thermal Store 1.0

Capacity	Standard					Solar				
	200L	250L	300L	400L	500L	200L	250L	300L	400L	500L
<b>Code</b>	KCSMVI-0200LFC	KCSMVI-0250LFC	KCSMVI-0300NFC	KCSMVI-0400LFC	KCSMVI-0500LFC	KCSMVS-0200LFC	KCSMVS-0250LFC	KCSMVS-0300LFC	KCSMVS-0400LFC	KCSMVS-0500LFC
<b>Height (A)</b>	1490	1815	1600	1570	1900	1490	1815	1600	1570	1900
<b>Diameter (B)</b>	540	540	600	710	710	540	540	600	710	710
<b>Weight (empty)</b>	46	56	64	71	87	46	56	64	71	87
<b>Weight (full)</b>	243	302	360	471	589	243	302	360	471	589
<b>Hot water volume</b>	196	247	290	390	494	193	244	287	387	492
<b>C</b>	196	196	218	225	225	196	196	213	225	225
<b>D</b>	296	296	318	325	325	486	584	518	530	630
<b>E</b>	396	396	418	425	425	586	685	618	630	730
<b>F</b>	576	656	648	655	765	576	656	648	655	765
<b>G</b>	636	721	708	730	815	526	606	563	575	675
<b>H</b>	821	1038	913	920	1154	821	1038	913	920	1154
<b>I</b>	921	1138	1013	1020	1254	921	1138	1013	1020	1254
<b>J</b>	1206	1526	1328	1285	1635	1206	1526	1328	1285	1635
<b>K</b>	-	-	-	-	-	636	721	703	730	815
<b>Energy Efficiency Class</b>	<b>C</b>	<b>C</b>	<b>C</b>	<b>C</b>	<b>C</b>	<b>C</b>	<b>C</b>	<b>C</b>	<b>C</b>	<b>C</b>
<b>Standing Loss (W)</b>	81	87	92	102	115	83	89	96	102	115

## Thermal Store 2.0

Cyclone

C



The Joule Cyclone Thermal Store 2.0 is the ideal solution for multi energy applications. The hot water is produced through the fresh water module mounted on the front of the tank. This provides far superior flow rates compared with the older internal coil version. The tank has many direct connections to allow for multiple heat sources and heat zones. The tank is manufactured from stainless steel and has the usual quality outer casing that you expect from a Joule Cyclone cylinder.

- 3kW Incoloy immersions fitted as standard
- Solar coil option available
- Female connections throughout
- Bevelled stat pocket for better fitting
- Metallic grey wipe clean rigid case for premium appearance
- Ideal multi energy tank solution
- 1" direct connections
- Butt Welded process used throughout
- Robotically welded
- Branded quality components
- Multiple system schematics available in installation manual

joule

## Dimensions

### Thermal Store 2.0 Standard

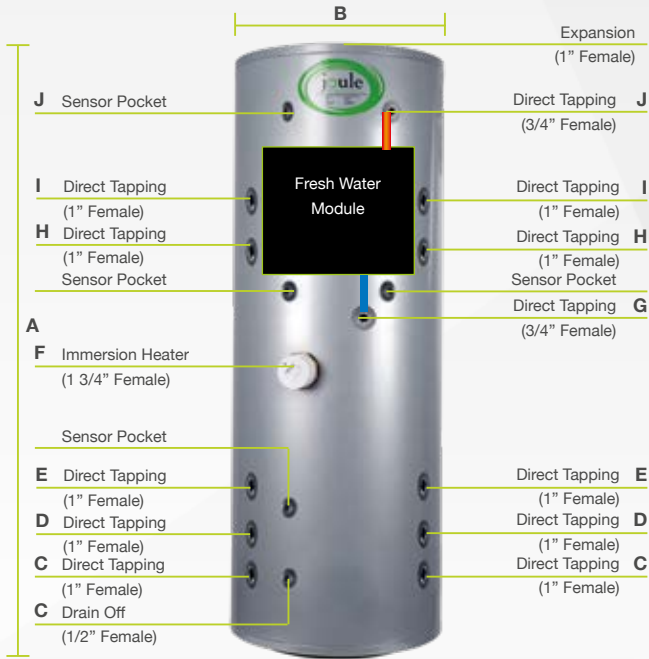

### Thermal Store 2.0 Solar

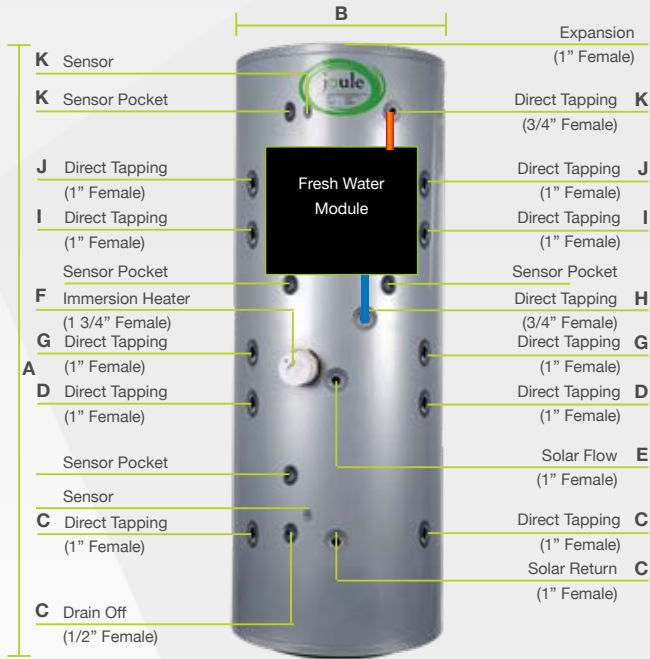

## Thermal Store 2.0

Capacity	Standard			Solar				
	250L	300L	500L	200L	250L	300L	400L	500L
<b>Code</b>	KCZMVI-0250LFC	KCZMVI-0300LFC	KCZMVI-0500LFC	KCZMVS-0200LFC	KCZMVS-0250LFC	KCZMVS-0300LFC	KCZMVS-0400LFC	KCZMVS-0500LFC
<b>Height (A)</b>	1400	1600	1900	1490	1400	1600	1570	1900
<b>Diameter (B)</b>	600	600	710	540	600	600	710	710
<b>Weight (empty)</b>	56	64	87	46	56	64	71	87
<b>Weight (full)</b>	302	360	589	243	302	360	471	589
<b>Hot water volume</b>	247	290	494	193	244	287	387	492
<b>C</b>	218	213	225	196	218	213	225	225
<b>D</b>	318	313	325	486	468	518	530	630
<b>E</b>	418	413	425	526	468	563	575	675
<b>F</b>	508	643	765	586	568	618	630	730
<b>G</b>	653	653	815	576	508	643	655	765
<b>H</b>	789	908	1154	606	558	653	655	815
<b>I</b>	889	1008	1254	821	789	908	920	1154
<b>J</b>	1128	1323	1635	921	889	1008	1020	1254
<b>K</b>	-	-	-	1206	1128	1323	1275	1635
<b>Energy Efficiency Class</b>	<b>C</b>	<b>C</b>	<b>C</b>	<b>C</b>	<b>C</b>	<b>C</b>	<b>C</b>	<b>C</b>
<b>Standing Loss (W)</b>	87	92	115	83	89	96	102	115

## Mild Steel Buffer Tanks



Joule Mild Steel Buffer Tanks are suitable for all hot water central heating systems, regardless of whether they are powered by solid fuel or oil-fired boilers, heat pumps, solar energy systems or continuous flow heaters (gas or electric). Several buffer tanks can also be combined in a row (see technical data and accessories), meaning the tank volume can be adjusted individually depending on the requirements. Furthermore, the buffer tanks can also be used for cold water storage in cooling processes (up to 3 bar operating / system pressure) or heat recovery in industrial facilities.

- Nominal capacity of 300 to 5000 litres
- Made from quality St 37-2 steel
- 100 mm ECO SKIN fleece insulation (up to 5,000 l)
- Large-surface pipe array on PSR/PSRR models
- 240 mm flange on PSF models for installing a finned tube heta exchanger or built-in heater
- Operating pressure = 3 bar, test pressure 4.5 bar in buffer tank
- Operating pressure max. 10 bar, test pressure 15 bar in pipe array on PSR/PSRR models
- 4 regulating sleeve threads. „Female thread on PSF/PSM and PSR/PSRR models
- 2x sensor channels for variable positioning of sensor models
- Operating temperature = 95°C (110°C in pipe array)
- External powder coating up to 2000 litres
- External anti-rust coating (from 3,000 l upwards)



### Dimensions (300-2000L)

### Dimensions (3000-5000L)

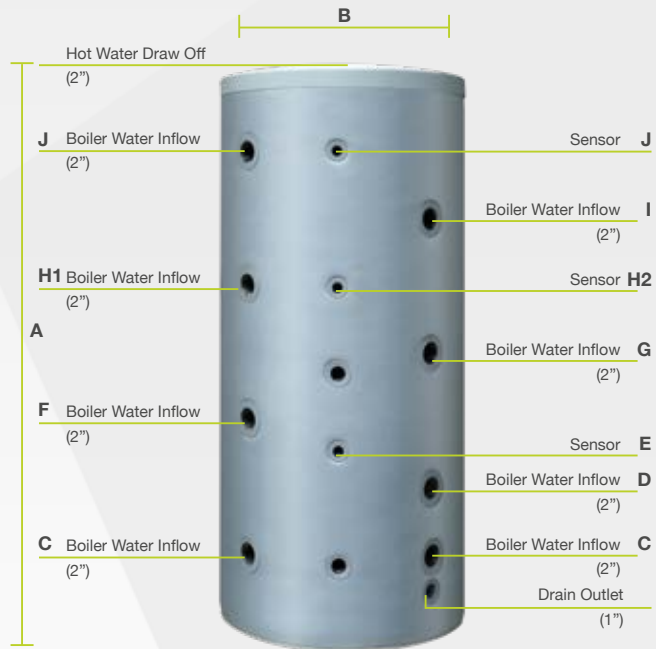
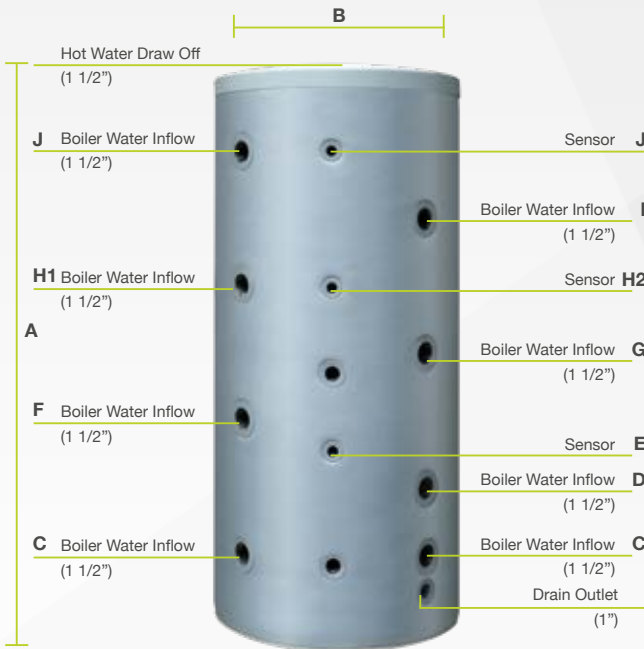

### Buffer

Capacity	100L	200L	300L	400L	500L	800L	1000L	1500L	2000L	3000L	4000L	5000L
<b>Code Without Coil</b>	BBMSD-00100NFC	BBMSD-00200NFC	BBMSD-00300NFC	BBMSD-00400NFC	BBMSD-00500NFC	BBMSD-00800NFC	BBMSD-01000NFC	BBMSD-01500NFC	BBMSD-02000NFC	BBMSD-03000NFC	BBMSD-04000NFC	BBMSD-05000NFC
<b>Code With Coil</b>	-	BBMSI-00200NFC	BBMSI-00300NFC	BBMSI-00400NFC	BBMSI-00500NFC	BBMSI-00800NFC	BBMSI-01000NFC	BBMSI-01500NFC	BBMSI-02000NFC	BBMSI-03000NFC	BBMSI-04000NFC	BBMSI-05000NFC
<b>Height (A)</b>	1100	1105	1450	1830	1900	1730	2050	2000	2500	2750	2355	2855
<b>Diameter (B)</b>	550	750	750	750	550	790	790	1100	1100	1250	1600	1600
<b>Weight (empty)</b>	50	60	75	90	105	125	150	210	235	300	380	440
<b>Hot water volume</b>	111	223	305	387	467	728	883	1479	2023	2935	3985	4981
<b>C</b>	220	220	220	220	215	250	250	385	385	410	445	445
<b>D</b>	-	-	390	450	455	435	500	660	660	725	675	760
<b>E</b>	130	315	500	575	610	570	570	485	800	825	790	920
<b>F</b>	-	485	560	680	675	620	740	-	930	1040	910	1075
<b>G</b>	-	555	730	905	915	820	980	1152	1205	1360	1140	1390
<b>H1</b>	-	605	900	1135	1145	1020	1240	960	1480	1680	1365	1705
<b>H2</b>	820	785	900	1135	1145	1020	1240	1122	1480	1680	1365	1705
<b>I</b>	-	785	1070	1365	1375	1215	1485	1535	1755	1995	1605	2020
<b>J</b>	885	885	1235	1580	1605	1410	1730	1435	2025	2310	1840	2335
<b>Energy Efficiency Class</b>	<b>C</b>	<b>C</b>	<b>C</b>	<b>C</b>	<b>C</b>	<b>C</b>	<b>C</b>	<b>C</b>	<b>C</b>	<b>C</b>	<b>C</b>	<b>C</b>
<b>Max Working Pressure</b>	0.3	0.3	0.3	0.3	0.3	0.3	0.3	0.3	0.3	0.3	0.3	0.3
<b>Max Working Temperature</b>	95	95	95	95	95	95	95	95	95	95	95	95

# Stainless Steel Buffer Tanks



Capacity	100L	125L	150L	170L	200L	250L	300L	400L	500L	600L
Code Without Coil	BBSSD-00100NFC	BBSSD-00125NFC	BBSSD-00150NFC	BBSSD-00170NFC	BBSSD-00200NFC	BBSSD-00250NFC	BBSSD-00300NFC	BBSSD-00400NFC	BBSSD-00500NFC	BBSSD-00600NFC
Code With Coil	-	-	BBSSI-00150NFC	BBSSI-00170NFC	BBSSI-00200NFC	BBSSI-00250NFC	BBSSI-00300NFC	BBSSI-00400NFC	BBSSI-00500NFC	BBSSI-00600NFC
Height (mm)	950	1030	1190	1310	1490	1815	1600	1570	1900	2200
Diameter (mm)	500	540	540	540	540	540	600	710	710	710
Weight Empty (kg)	22	26	30	32	34	43	47	62	75	90
Weight Full (kg)	122	151	180	202	234	293	347	462	575	690
No. Direct Connections	7	7	7	7	9	9	9	9	9	9
Diameter of Direct Connections	1"	1"	1"	1"	1"	1"	1"	1"	1"	1"
Drain Off	1/2"	1/2"	1/2"	1/2"	1/2"	1/2"	1/2"	1/2"	1/2"	1/2"
Standard Standing Loss (kWh/Day)	1.11	1.23	1.41	1.53	1.8	2.15	2.28	2.41	2.54	2.71
Eco80 Standing Loss (kWh/Day)	1.01	1.16	1.36	1.44	1.69	1.91	2.15	2.25	2.38	2.59

# Current Unvented Kit Components

**RWC Inlet Control Group 22mm**



TZG-3.0-RO.75I

**Tundish**



TZU-000015X22  
TZU-000015X22  
TZU-000015X22

**Dual Cylinder Thermostat**



TZC-D-0000000Z

**Expansion Vessel**



TV-P0-0000012L      TV-P0-0000024L  
TV-P0-0000019L      TV-P0-0000035L  
TV-P0-0000050L

**Zone Valve**



TZM-I-000022MM  
TZM-I-000028MM

**T&P Valve**



TZ9-4.0-000.50  
TZ9-4.0-000.75  
TZ9-7.0-001.00

**RWC Inet Control Group P Valve**



TZG-P-0-000RC6

**Hi Limit Single Thermostat**



TZC-S-0000000Z

**1" RWC Combination Valve**



TZG-6.0-00001I

# Pre-Plumbed Cylinder Components

**Filling Loop Hose**



TZ-G-0-0000UKZ

**Joule Dial Type Thermostat**



UZS-A-00000000

**Digital Thermostat**



UZT-0000000001      UZT-0000000003  
UZT-0000000002      UZT-0000000004

**Heating Expansion Vessel**



TV-H0-0000012L      TV-H0-0000060L  
TV-H0-0000024L      TV-H0-0000080L

**Wiring Junction Box**



HZU-0000000000

**Automatic Air Vent**



PZ-A-O-00000Z

**A Rated Circulation Pump**



HZC-0000A25-60

# Samsung Heat Pump



## Heat your home using free energy from the outside air

The Samsung Eco Heating System utilises Heat Pump technology to use the heat energy from the ambient air, which is a free and renewable energy source, for low cost heating and hot water production.

## Efficient heating

An efficient Heat Pump system provides efficient heating and domestic hot water throughout the year, even in ambient temperatures of  $-25^{\circ}\text{C}$ .

## Compact installation

The EHS Mono system utilises an outdoor unit, which combines the refrigerant and water circuits, removing the need for internal installation space. The compact size and low noise level of the outdoor unit provides an unobtrusive solution for domestic applications.

## Hybrid capability

Available in a range of 5 outputs to suit most applications, the EHS Mono system includes flexible control options and Hybrid capability, whereby the system can be used in conjunction with Solar and/or Boiler installations.

## Simple operation

The simple to operate, sophisticated EHS controller is designed to maximise the use of renewable energy for even greater running cost savings, especially when compared to inefficient oil, gas or electric heating systems.



## Heat Pump Outdoor Units

				HHSM-G500005-1	HHSM-G500009-1	HHSM-G500012-1	HHSM-G500014-1	HHSM-G500016-1
Power Supply		Ø, #, V, Hz		1, 2, 220-240, 50	1, 2, 220-240, 50	1, 2, 220-240, 50	1, 2, 220-240, 50	1, 2, 220-240, 50
Performance (A2W #1)	Nominal Capacity <sup>*1)</sup>	Heating	W	5,000	9,000	12,000	14,000	16,000
	Nominal Current Input <sup>*1)</sup>	Heating	A	5.1	9.2	12	14.3	17.1
	SCOP <sup>*1)</sup>		-	4.510	4.409	4.454	4.489	4.481
Electric Specification	Max Current		A	16	22	28	30	32
Water Side	Piping Connections	In / Out	Ø, inch	1" (BSPP)	1" (BSPP)	1" (BSPP)	1" (BSPP)	1" (BSPP)
Refrigerant Side	Refrigerant	Type		R410A(GWP>150)				
Sound	Sound Pressure <sup>*3)</sup>	Heating	dB (A)	45	48	50	51	52
	Sound Power		dB (A)	61	63	64	65	66
External Dimension	Weight	Net	kg	59	76	108	108	108
	Dimensions (WxHxD)	Net	mm	880 x 798 x 310	940 x 998 x 330	940 x 1,420 x 330	940 x 1,420 x 330	940 x 1,420 x 330
Operating Range	Leaving Water	Heating	°C	25 ~ 55	25 ~ 55	25 ~ 55	25 ~ 55	25 ~ 55

\*1~2) A2W rating conditions in accordance with Eurovent Rating Standard for Liquid Chilling Packages RS-6/C/001-2011.

\*1) A2W Condition #1 : (Heating) Water In/Out 30°C/35°C, Outdoor Air 7°CDB/6°CWB.

\*3) Sound Pressure was acquired in an anechoic room. Thus actual noise level may be different depending on the installation conditions.

## Control Kit

				HHSMC-G5000005	HHSMC-G5000000
Use with				5kW Mono	9,12,14&16kW mono
Power Supply		Ø, V, Hz		5,000	9,000
External Dimension	Weight	Net	kg	5	5
	Dimensions (WxHxD)	Net	mm	290 x 371 x 110	290 x 371 x 110

\*External Control Options - 230V: (Max A)

Booster Heater (20A), hybrid (0.5A), water pump (2A), 2/3way valve (0.5A),

Thermostat (10mA), solar pump (10mA), Inverter pump (2A), 3way mixing valve (0.5A)

Wi-Fi Kit (MIM-H03N) optional accessory.

Control App available to download. (Phone not included.)



# Smart Plumb Heat Pump

Cyclone



The Smart Plumb by Joule is the most innovative pre-plumbed solution for heat pump systems. The cylinder/buffer combo is pre-plumbed, wired and commissioned before it leaves the factory. The buffer / low loss header acts as an intermediary vessel for the heating system which helps system flow rate and defrost cycling. With the cylinder sitting over the buffer tank the foot print has been greatly reduced. The control wires are all hidden behind the cable cover. The pipework is manufactured from 316L stainless tube.

joule

## System Components

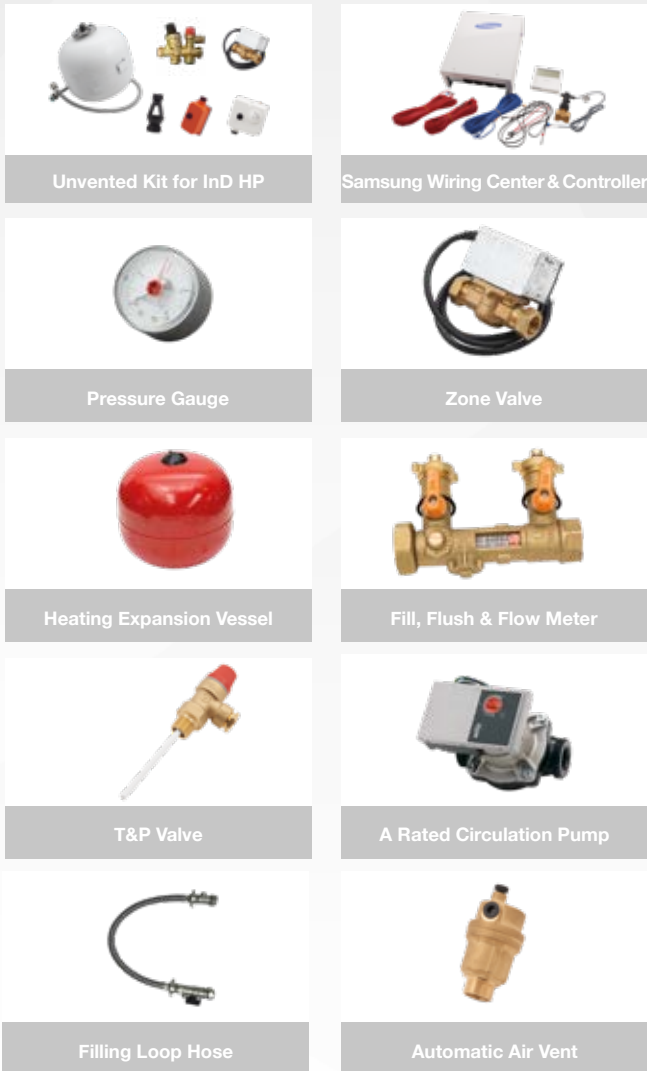

## Dimensions

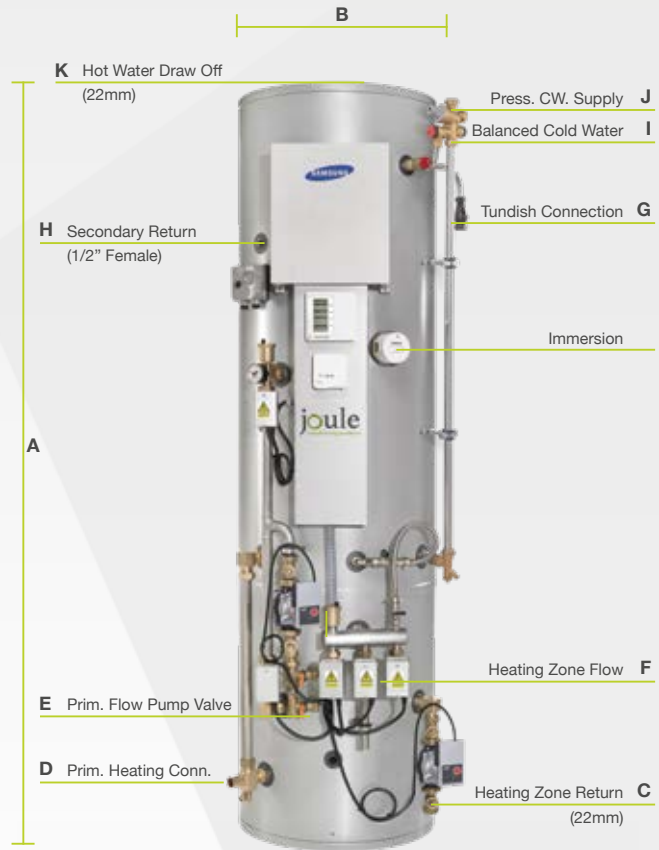

## Smart Plumb Heat Pump

Capacity (cyl+buffer)	180+60L	200+60L	200+90L	250+90L	300+90L	300+130L	400+130L
Height	1870	1980	1670	1950	2150	1850	2160
Diameter	540	540	600	600	600	710	710
<b>Hot water volume</b>							
C	200	200	200	200	200	200	200
D	220	220	220	220	220	220	220
E	500	500	500	500	500	500	500
F	550	550	550	550	550	550	550
G	1470	1550	1250	1520	1700	1450	1760
H	1520	1600	1300	1570	1750	1500	1810
I	1790	1900	1590	1870	2070	1770	2080
J	1820	1930	1620	1900	2100	1800	2110
K	1870	1980	1670	1950	2150	1850	2160
Energy Efficiency Class	B / B	C / B	C / B	C / B	C / B	C / B	C / B
Heat up Time - coil (Mins)	55	66	78	87	92	102	

## Aero Direct



The Joule Hybrid Solar Dynamic hot water cylinder is a new innovative solution for your hot water needs.

Suitable for both domestic and commercial applications, this outstanding product from a design and running cost perspective has never been witnessed before.

Our in-house R&D engineers have spent 3 years designing and testing this new technology.

The concept is very simple, extracting the latent heat from the air and transferring this energy to the water in the tank using the refrigeration process.



### System Components

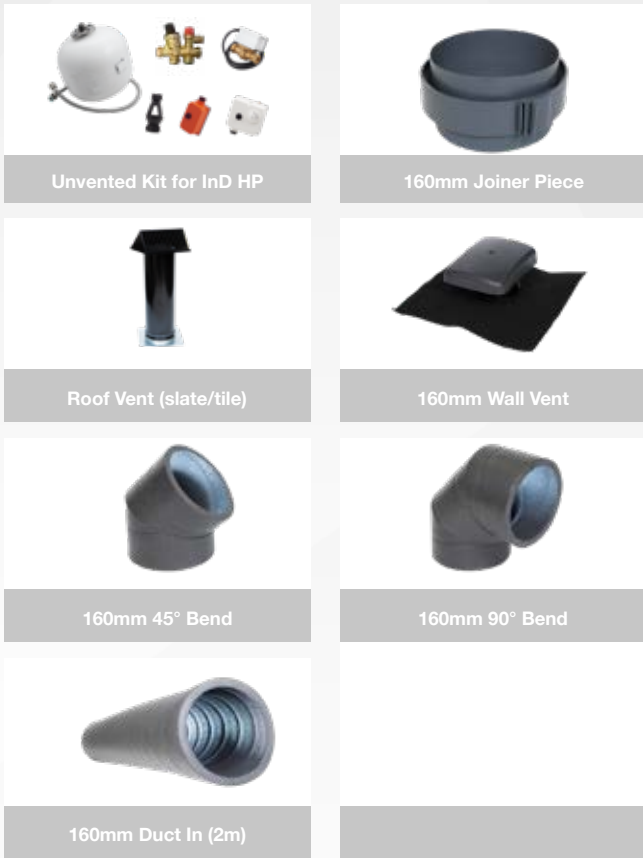

### Dimensions - Standard

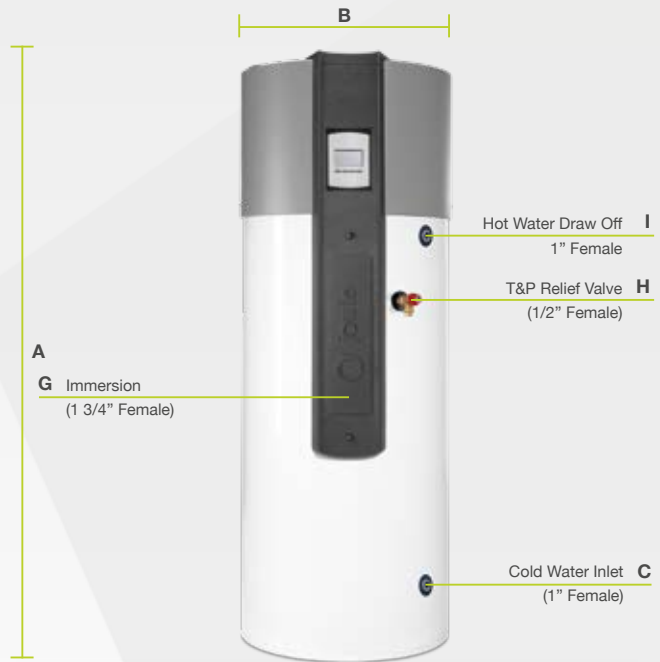

### Aero

Capacity	Standard			Solar		
	210	260L	300L	210L	260L	300L
Length (A)	1625	1875	2075	1625	1875	2075
Diameter (B)	685	685	685	685	685	685
Hot water volume	200	250	290	200	250	290
C	222	222	222	222	222	222
D	-	-	-	272	272	272
E	-	-	-	347	367	392
F	-	-	-	522	572	622
G	611	861	1061	611	861	1061
H	882	1132	1332	882	1132	1332
I	1101	1351	1551	1101	1351	1551

### Dimensions - Solar

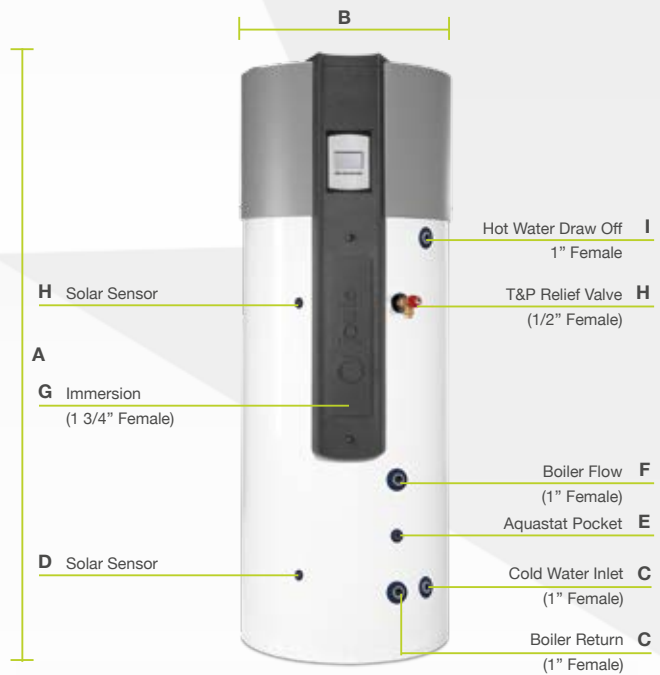

# Wellmaster



When you are looking to install a premium hot water cylinder on your private well or community group scheme, then you don't need to look any further than the Joule Wellmaster. Designed with aggressive water in mind the cylinder has significant design characteristics making it better suited to well water installations.

- Ground breaking innovative design specific to the Well Water Market
- Industry leading welding techniques which eliminate corrosion issues
- **Super Duplex** grade stainless steel chosen for better corrosion resistance
- **Sacrificial anode** protects cylinder from corrosion
- **Superior titanium** immersion supplied. Designed for longer life
- 10 year manufacturers standard warranty against manufacturing defects
- The only stainless steel cylinder available on the market that has a **guarantee against corrosion damage** due to aggressive water

To ensure that the cylinder remains protected and warranty is maintained you must ensure the anode is replaced when required.







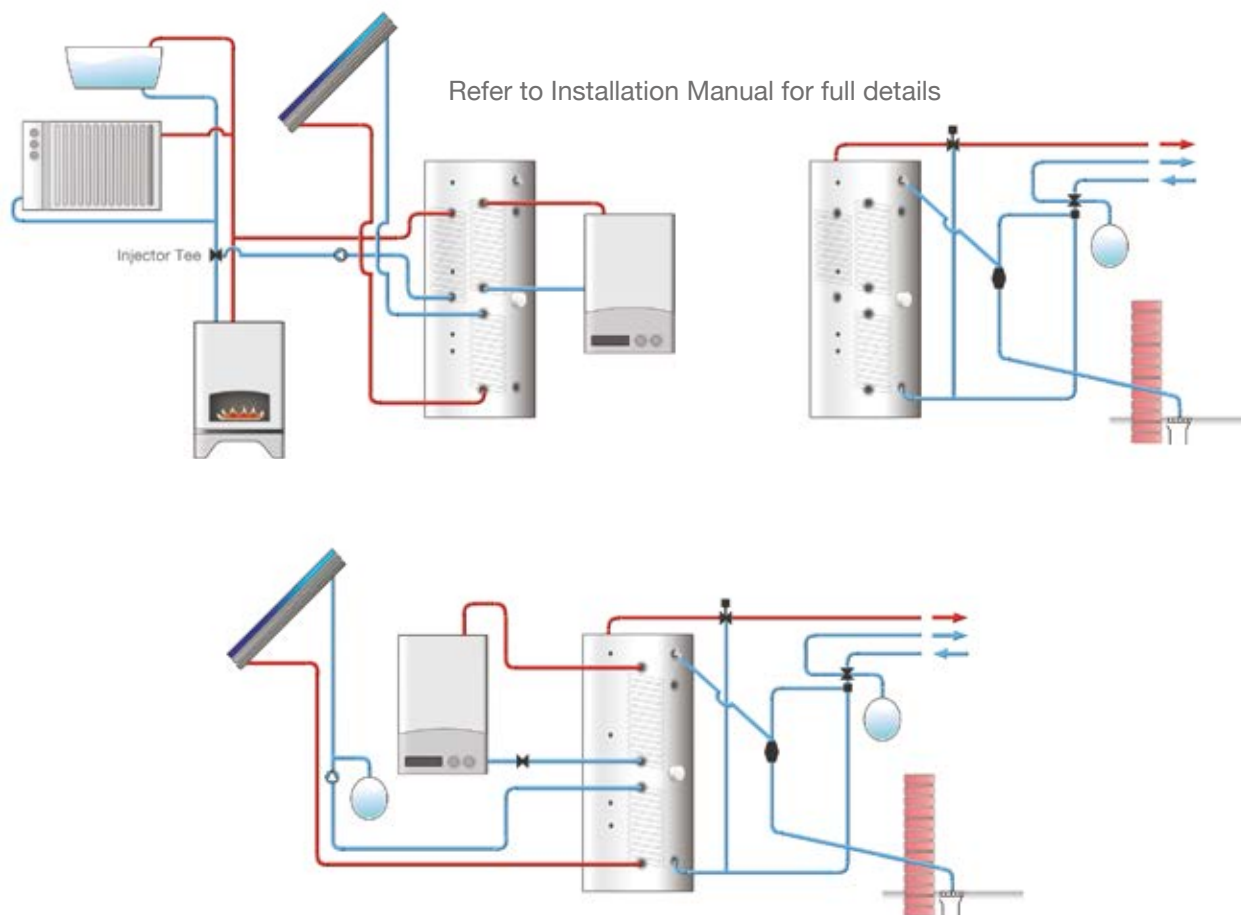

# Technical Information

Volume (l)	TWIN STANDARD						
	200	200	250	250	300	400	500
Height (mm)	1110	1445	1350	1775	1550	1550	1905
Diameter (mm)	600	530	600	530	600	710	710
Weight Empty (kg)	34	34	43	43	47	62	75
Weight Full (kg)	234	234	293	293	347	462	575
Reheat Indirect Total Minutes	26	26	26	26	32	35	35
Reheat 3 kW Immersion Total Min.	91	91	118	118	141	175	222
EN12897 Prim. Heat Exchng (kW)	18	18	22	22	22	28	35
EN12897 Solar Heat Exchng (kW)	16	16	18	18	18	22	22
Dedicated Solar Volume	110	110	135	135	160	210	260
Standard Standing Loss kWh/Day	1.8	1.8	2.15	2.15	2.28	2.41	2.54
Eco80 Standing Loss kWh/Day	1.59	1.59	1.69	1.69	1.91	2.15	2.25

Volume (l)	TRIPLE STANDARD				
	200	250	300	400	500
Height (mm)	1085	1335	1535	1535	1880
Diameter (mm)	560	560	560	660	660
Weight Empty (kg)	34	43	47	62	75
Weight Full (kg)	234	293	347	462	575
Reheat Indirect Total Minutes	26	26	32	35	35
Reheat 3 kW Immersion Total Min.	91	118	141	175	222
EN12897 Prim. Heat Exchng (kW)	18	22	22	28	35
EN12897 Solar Heat Exchng (kW)	16	18	18	22	22
EN12897 Aux. Heat Exchng (kW)	18	22	22	28	35
Dedicated Solar Volume	110	135	160	210	260
Standard Standing Loss kWh/Day	1.8	2.15	2.28	2.41	2.54
Eco80 Standing Loss kWh/Day	1.59	1.69	1.91	2.15	2.25

When using Eco80, dimensions will change to allow for extra insulation.



								
1	1	1	1	1	1	0	1	1
Temperature and Pressure Relief Valve	Expansion Vessel	High Flow Rate Inlet Control Set	Dual Thermostat	Incoloy Long 240V 3kW Immersion Heater	15/22 Tundish	22mm Thermostatic Mixing Valve	Expansion Vessel Hose	22 mm 2 Port Motorised Diverting Valve



InvaHeat design and supply underfloor heating systems to the residential, commercial and industrial sectors and can offer 'in-house' and 'on-site' support. We offer a choice of seven fixing systems for use with screeded, floating or joisted floors. We supply pipework, room temperature and water temperature controls. Our materials are complemented by a full planning, design and technical service.

## Warmth & comfort

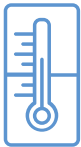

Joule have developed a wide ranging portfolio of solutions for heating and hot water systems. So whether it's a heat pump, underfloor heating or our industry leading SmartPlumb range of pre-plumbed cylinders, Joule have a solution for you.

## Well being

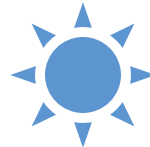

Underfloor heating provides a balanced level of radiant heat and air warming. If the heating is provided by high air temperatures this can dry the skin and eyes. Warming the floor reduces the occurrence of dust mites that cause allergies.

## Renewables



Renewable heat is easier to produce efficiently at low water temperatures. Underfloor heating uses low temperature water leaving an ideal match with renewable energy heat sources.

## Efficiency



InvaHeat's products are designed specifically to work at low water temperatures, improving the efficiency of the heat pump, reducing running costs and saving you money.

## System Types

### Lite

This is an ideal solution where you have the available floor to ceiling height to have a 50mm floor build up. It provides the best thermal insulation to prevent heat transferring downwards. Effectively four products in one, these Insulation Panels comprise a rigid thermal insulation material with grooves positioned in the upper surface.

<b>43/25</b> mm	<b>65</b> w/m <sup>2</sup>	<b>***</b>	<b>**</b>	 Size: 16mm Type: PERT
Floor Build Up Tiles/Timber	Output	Cost	Ease Of Installation	<b>Floating Floor System</b>

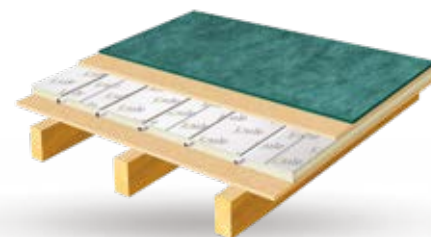

### Board

InvaHeats pre-grooved cement boards offer an ideal fast-fit, 18mm floor build up with a high output underfloor heating system. Used in conjunction with our structural plastic floor panel at either end of the room to enable turning and routing of pipe this unique system can be installed directly onto both screed or wood floors.

<b>18/36</b> mm	<b>65</b> w/m <sup>2</sup>	<b>*</b>	<b>**</b>	 Size: 12mm Type: PERT
Floor Build Up Concrete/Joists	Output	Cost	Ease Of Installation	<b>Overlay Floor System</b>

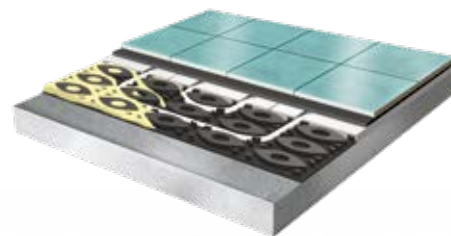

### Plate

The aluminium spreader plate system is an ideal solution for a suspended timber floor both upstairs or downstairs. The spreader plates fix to the joists and have preformed channels built in to take the pipe and also help radiate the heat from the pipe to the space above it. The finished floor can be laid directly over the spreader plates.

<b>0</b> mm	<b>55</b> w/m <sup>2</sup>	<b>***</b>	<b>*</b>	 Size: 16mm Type: PERT
Floor Build Up	Output	Cost	Ease Of Installation	<b>Suspended Floor System</b>

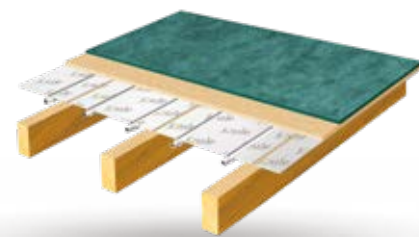

### Matt

The aluminium spreader plate system is an ideal solution for a suspended timber floor both upstairs or downstairs. The spreader plates fix to the joists and have preformed channels built in to take the pipe and also help radiate the heat from the pipe to the space above it. The finished floor can be laid directly over the spreader plates.

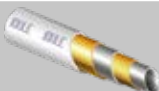
<b>70</b> mm	<b>90</b> w/m <sup>2</sup>	<b>****</b>	<b>****</b>	 Size: 16mm Type: PERT
Floor Build Up	Output	Cost	Ease Of Installation	<b>Solid Floor System</b>

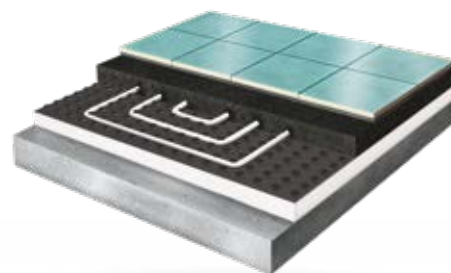

## Joule Manifold

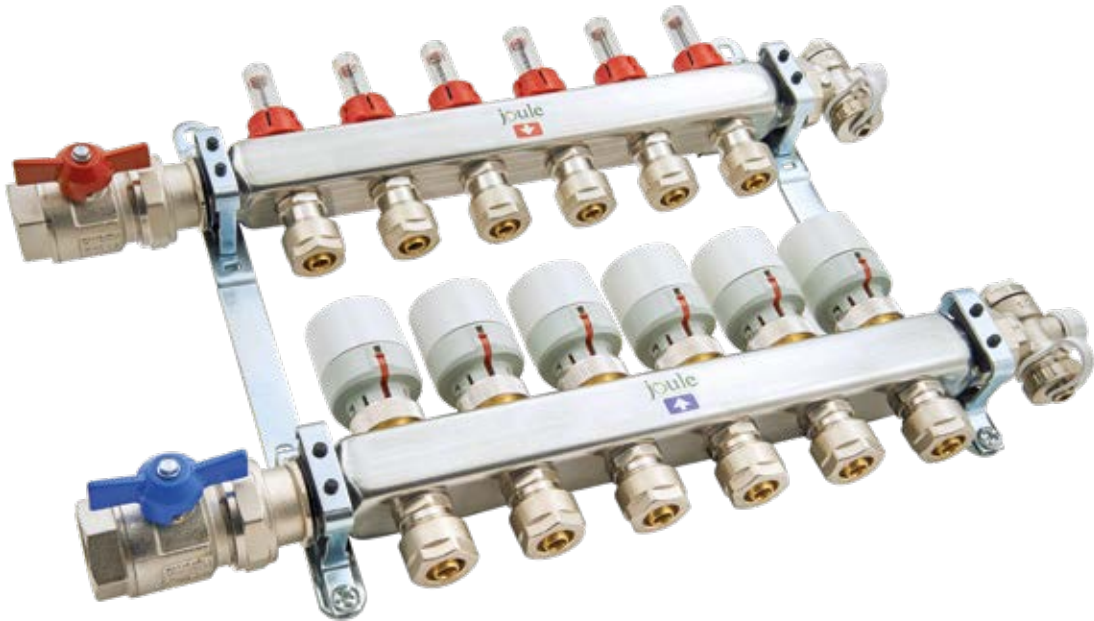

## Multilayer Aluminium Pert/Al/Pert Pipe

The Joule pert/al/pert multilayer aluminium barriered pipe is manufactured using a 5 layer technology. It has an aluminium middle layer that protects the pipe from accidental damage during installation and prolongs its use over the life span of the system. The pipe comes in coils ranging from 50 meters to 500 meters.

- To prove the quality of our European manufactured pipe we have Kiwa certification
- MULTI-PEX pipe manufactured according to EN ISO 15875
- EVOH layer oxygen barrier in accordance with DIN 4726
- Operational range -90°C max @ 6 bar, constant temperature 70°C, max peak 100°C
- EVOH oxygen barrier protected in central core
- Available in 50, 75, 100, 200 and 500m coils
- Sizes available Ø - 12x2, 16x2, 20x3 mm

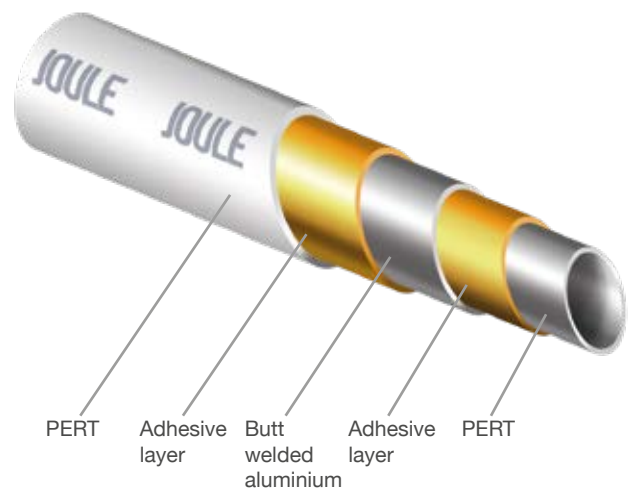

# Underfloor Controls

## Overview

Controls are an essential part of any heating system as they create your environment in the most efficient and cost effective way possible. This means ensuring that your system only operates when required and for the minimum period of time.

There are various methods of doing this but all are managed by your control system with various levels of integration between the heating zone, heat source and outside temperature. The control system must be accurate and sophisticated as well as easy to use! Room temperature control for underfloor heating is measured by ambient room temperature controllers that are located in each zone. These are linked to the local manifold wiring centre.

**InvaHeat** provides a wide variety of controls to fit every scenario, whether it is wired, wireless or networked.

The majority of our room thermostats are designed to be flush mounted, resulting in a slim profile on the wall after installation. We offer a variety of options from wired and wireless to fully networked systems, with the option to control via our central control pad.

## Joule Touchscreen Thermostat

The newly launched Joule Touchscreen Thermal Stat is a state-of-the-art solution to use in every underfloor heating system. You can use the top and bottom buttons on the left hand side of the stat to change the room temperature up and down. The top right button is where you program in your time periods and the bottom right button is where you turn it off.

The Joule stat is designed to be flush mounted so it must be fitted to a single gang back box which will be installed during first fix.

The stat is a 240V mains stat and as such requires a 3-core insulated cable to be installed connecting the stat to the wiring center.



## Wifi Smart Thermostat

The NEO system is designed to provide reliable communication of the thermostat data whilst at the same time providing an extended communication range.

Each NEO thermostat acts as a repeater on the NEO system network, helping eliminate range issues. The Neo system has been designed to offer complete local and App control of your heating, hot water and plug-in appliances. With Neo you can control your heating from anywhere using your smartphone.



# Acapella System

High efficiency evacuated tube solar system



The Joule Acapella Solar system's unique tube design ensures a very high zero-loss collector efficiency figure of 85% based on the absorber. The unique method of fixing the tubes into the collector results in a significantly lower heat loss coefficient of 1.529w/m<sup>2</sup>K. The collectors easy to install frame ensures that the collector is securely fixed and mounted onto the roof every time.

- We are so confident of the quality of our solar collectors that we have tested our collectors to double and sometimes four times the requirements of EN12975:1-2 and they are Solar Keymark.
- The high efficiency collectors are further tested to determine the maximum positive and negative loading force that the collectors can resist.
- The collectors have been tested to determine their impact resistance using a steel and ice ball methods.

**20  
TUBE**

SX-E-000000020  
1690 x 2000 x 189



1-2



200L

**30  
TUBE**

SX-E-000000030  
2610 x 2000 x 189



3-4



250L

**40  
TUBE**

SX-E-000000040  
3380 x 2000 x 189



4-5



300L

**50  
TUBE**

SX-E-000000050  
4300 x 2000 x 189



5-6



400L

**60  
TUBE**

SX-E-000000060  
5220 x 2000 x 189



6-7



500L



# Specifications

## System Components



### Solar Pump Station

a combination unit that moves the heat into your hot water cylinder



### Solar Controller

manages the efficient transfer of solar heat energy from the collectors to the water storage tank



### Expansion Vessel

protects closed water heating systems and domestic hot water systems from excessive pressure



### Solar Fluid

heat transfer medium for solar heating applications with high temperature stability



### Mounting Options

all you need for tile, slate or flat roof mounting options.

## Additional Accessories



### Mixing Valve

blends hot water with cold water to ensure constant, safe shower/bath temperatures



### DN16 Pipes

pre-insulated pipe for solar hot water systems with pre-installed flow and return pipe



### Flashings

specifically designed to be used in roofing applications for flashing of round penetrations



### Overvoltage Protection

helps to avoid overvoltage damage to the solar controller, eg. caused by lightning storms



### Data Logger

enables the acquisition and storage of large amounts of data with PC, iPhone, iPad integration



### Discharge Vessel

drain off vessel for solar thermal systems

System Size	Dimensions		
	10 Tube Collector	20 Tube Collector	30 Tube Collector
Gross area (m <sup>2</sup> )	1.72	3.38	4.901
Aperture area (m <sup>2</sup> )	0.93	1.86	2.791
Absorber area (m <sup>2</sup> )	0.80	1.61	2.411
Collector Height (m)	2.01	2.01	2.01
Manifold width (m)	1.2	1.8	2.42
Length of tube (m)	1.8	1.8	1.8
Distance between tubes/panels (m)	0.078	0.078	0.078
Weight empty (kg)	52	85	106
Max operating pressure (bar)	6	6	6
Recommended operating pressure (bar)	2-3	2-3	2-3
Recommended flow rate (l/min)	0.47	0.95	1.4
Fluid volume in collector (l)	0.81	1.65	2.3
Rated heat output (kW)	0.60	1.21	1.81

Materials	
Absorber (cylindrical shape)	Aluminium
Coating	Aluminium Nitrite
Absorbance	> 94%
Emissivity	< 7%
Mounting frame	Aluminium, Stainless Steel
Glass	Borosilicate Glass
Mounting inclination	15°-75°
Inlet outlet dimensions (inch)	3 1/4 bracket male
Stagnation temperature (°C)	200.3
Insulation material	Mineral wool+Polyurethane
Heat transfer fluid	Glycol mix
Efficiency Constants for G=8000W/m <sup>2</sup> (Aperture Area)	$\eta_0 = 0.734$ $a_1 = 1.529$ $a_2 = 0.0166$ (W/m <sup>2</sup> K)

## Mounting Options



- 1a Sloped roof bolt kit
- 1b Sloped roof slate mounting bracket
- 1c Sloped roof tile mounting bracket
- 2 25° increase roof inclined bracket
- 3 45° flat roof inclined roof bracket

## Joule Acapella Dimensions (mm)

	Length	Width	Height
<b>10 Tube Collector</b>	2010	854	189
<b>20 Tube Collector</b>	2010	1680	189
<b>30 Tube Collector</b>	2010	2420	189

# Navitas 2m/2.5m On-roof System

High efficiency on-roof solar system



The sleek Joule Navitas On-roof solar system is designed and manufactured to work in Northern European climates. The collector's black finish makes it an attractive addition to any roof. The unique patented ventilation system ensures the collector provides maximum output while reducing heat loss from inside the collector.

- We are so confident of the quality of our solar collectors that we have tested to double and sometimes four times the requirements of EN12975:1-2 and they are Solar Keymark.
- The high efficiency collectors are further tested to determine their maximum impact force resistance levels and the maximum positive and negative loading force that the collectors can resist.
- The Joule Navitas range offers both vertical and horizontal options
- All testings has been carried out by the Building Research Establishment (BRE) in Watford.

**1**  
PANEL

SX-OR-2.0-0-01  
SX-OR-2.5-0-01  
1170 x 1730 x 83



1-2



200L

**2**  
PANEL

SX-OR-2.0-0-02  
SX-OR-2.5-0-02  
2340 x 1730 x 83



3-4



250L

**3**  
PANEL

SX-OR-2.0-0-03  
SX-OR-2.5-0-03  
3510 x 1730 x 83



4-5



300L

**4**  
PANEL

SX-OR-2.0-0-04  
SX-OR-2.5-0-04  
4680 x 1730 x 83



5-6



400L

**5**  
PANEL

SX-OR-2.0-0-05  
SX-OR-2.5-0-05  
5850 x 1730 x 83



6-7









500L

# Specifications

## System Components

 <p><b>Solar Pump Station</b> a combination unit that moves the heat into your hot water cylinder</p>	 <p><b>Solar Controller</b> manages the efficient transfer of solar heat energy from the collectors to the water storage tank</p>	 <p><b>Expansion Vessel</b> protects closed water heating systems and domestic hot water systems from excessive pressure</p>	 <p><b>Solar Fluid</b> heat transfer medium for solar heating applications with high temperature stability</p>	 <p><b>Mounting Options</b> all you need for tile, slate or flat roof mounting options.</p>
--	--	---	--	--

## Additional Accessories

 <p><b>Mixing Valve</b> blends hot water with cold water to ensure constant, safe shower/bath temperatures</p>	 <p><b>DN16 Pipes</b> pre-insulated pipe for solar hot water systems with pre-installed flow and return pipe</p>	 <p><b>Flashings</b> specifically designed to be used in roofing applications for flashing of round penetrations</p>	 <p><b>Overvoltage Protection</b> helps to avoid overvoltage damage at collectors, eg. caused by lightning storms</p>	 <p><b>Data Logger</b> enables the acquisition and storage of large amounts of data with PC, iPhone, iPad integration</p>
 <p><b>Discharge Vessel</b> drain off vessel for solar thermal systems</p>				

Navitas 2m	
Dimensions	
Gross area (m <sup>2</sup> )	2.02
Aperture area (m <sup>2</sup> )	1.93
Absorber area (m <sup>2</sup> )	1.85
Collector height (m)	0.083
Collector width (m)	1.17
Collector length (m)	1.73
Weight (kg)	32
Max operating pressure (bar)	10
Recommended operating pressure (bar)	6.
Recommended flow rate (l/h/m <sup>2</sup> )	15 - 65.
Fluid volume in collector (l)	1.95.

Navitas 2.5m	
Dimensions	
Gross area (m <sup>2</sup> )	2.517
Aperture area (m <sup>2</sup> )	2.404
Absorber area (m <sup>2</sup> )	2.314
Collector height (m)	0.083
Collector width (m)	1.17
Collector length (m)	2.15
Weight (kg)	39
Max operating pressure (bar)	10
Recommended operating pressure (bar)	6.
Recommended flow rate (l/h/m <sup>2</sup> )	15 - 65.
Fluid volume in collector (l)	1.95.

Materials	
Absorber (flat plate)	Aluminium
Coating	Highly selective vacuum coated
Absorbance	95%
Emissivity	5%
Casing / Manifold	Extruded Aluminium
Glass	3.2mm Tempered solar safety glass
Mounting inclination	15° - 75°
Inlet outlet dimensions (inch)	3 1/4 flat seal threaded connection.
Stagnation temperature (°C)	184 °C under test conditions
Insulation material	40mm Mineral wool
Heat transfer fluid	Propylene glycol / water mixture
Efficiency Constants for G=8000W/m <sup>2</sup> (Aperture Area)	$\eta_0 = 0.794$ $a_1 = 4.164$ $a_2 = 0.008$ (W/m <sup>2</sup> K)

Materials	
Absorber (flat plate)	Aluminium
Coating	Highly selective vacuum coated
Absorbance	95%
Emissivity	5%
Casing / Manifold	Extruded Aluminium
Glass	3.2mm Tempered solar safety glass
Mounting inclination	15° - 75°
Inlet outlet dimensions (inch)	3 1/4 threaded connection.
Stagnation temperature (°C)	181 °C under test conditions
Insulation material	40mm Mineral wool
Heat transfer fluid	Propylene glycol / water mixture
Efficiency Constants for G=8000W/m <sup>2</sup> (Aperture Area)	$\eta_0 = 0.785$ $a_1 = 3.594$ $a_2 = 0.014$ (W/m <sup>2</sup> K)

# Navitas 2m In-roof System

High efficiency in-roof solar system



The sleek Joule Navitas In-roof solar system is designed and manufactured to work in Northern European climates. The collector's black finish makes it an attractive addition to any roof. The unique patented ventilation system ensures the collector provides maximum output while reducing heat loss from inside the collector.

- We are so confident of the quality of our solar collectors that we have tested to double and sometimes four times the requirements of EN12975:1-2 and they are Solar Keymark.
- The high efficiency collectors are further tested to determine their maximum impact force resistance levels and the maximum positive and negative loading force that the collectors can resist.

## 1 PANEL

SX-IRS-2.0-0-0001  
SX-IRT-2.0-0-0001  
SX-IRS-2.5-0-0001  
SX-IRT-2.5-0-0001  
1070 x 2100 x 122



1-2



200L

## 2 PANEL

SX-IRS-2.0-0-0002  
SX-IRT-2.0-0-0002  
SX-IRS-2.5-0-0002  
SX-IRT-2.5-0-0002  
2140 x 2100 x 122



3-4



250L

## 3 PANEL

SX-IRS-2.0-0-0003  
SX-IRT-2.0-0-0003  
SX-IRS-2.5-0-0003  
SX-IRT-2.5-0-0003  
3210 x 2100 x 122



4-5



300L

## 4 PANEL

SX-IRS-2.0-0-0004  
SX-IRT-2.0-0-0004  
SX-IRS-2.5-0-0004  
SX-IRT-2.5-0-0004  
4280 x 2100 x 122



5-6



400L

## 5 PANEL

SX-IRS-2.0-0-0005  
SX-IRT-2.0-0-0005  
SX-IRS-2.5-0-0005  
SX-IRT-2.5-0-0005  
5350 x 2100 x 122



6-7



500L

# Specifications

## System Components



### Solar Pump Station

a combination unit that moves the heat into your hot water cylinder



### Solar Controller

manages the efficient transfer of solar heat energy from the collectors to the water storage tank



### Expansion Vessel

protects closed water heating systems and domestic hot water systems from excessive pressure



### Solar Fluid

heat transfer medium for solar heating applications with high temperature stability

## Additional Accessories



### Mixing Valve

blends hot water with cold water to ensure constant, safe shower/bath temperatures



### DN16 Pipes

pre-insulated pipe for solar hot water systems with pre-installed flow and return pipe



### Flashings

specifically designed to be used in roofing applications for flashing of round penetrations



### Overvoltage Protection

helps to avoid overvoltage damage at collectors, eg. caused by lightning storms



### Data Logger

enables the acquisition and storage of large amounts of data with PC, iPhone, iPad integration



### Discharge Vessel

drain off vessel for solar thermal systems

## Tile Roof Flashing System

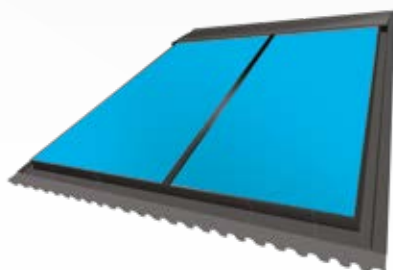

## Slate Roof Flashing System

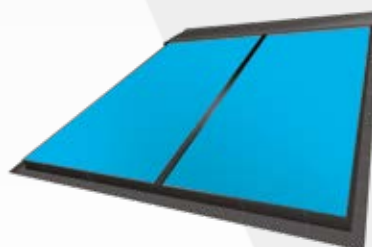

Dimensions	
Dimensions	
Gross area (m <sup>2</sup> )	2.02
Aperture area (m <sup>2</sup> )	1.93
Absorber area (m <sup>2</sup> )	1.85
Collector height (m)	0.083
Collector width (m)	1.17
Collector length (m)	1.73
Weight (kg)	32
Max operating pressure (bar)	10
Recommended operating pressure (bar)	6
Recommended flow rate (l/h/m <sup>2</sup> )	15 - 65
Fluid volume in collector (l)	1.95

Materials	
Absorber (flat plate)	Aluminium
Coating	Highly selective vacuum coated
Absorbance	95%
Emissivity	5%
Casing / Manifold	Extruded Aluminium
Glass	3.2mm Tempered solar safety glass
Mounting inclination	15° - 75°
Inlet outlet dimensions (inch)	3 1/4 flat seal threaded connection.
Stagnation temperature (°C)	184 °C under test conditions
Insulation material	40mm Mineral wool
Heat transfer fluid	Propylene glycol / water mixture
Efficiency Constants for G=8000W/m <sup>2</sup> (Aperture Area)	$\eta_0 = 0.794$ $a_1 = 4.164$ $a_2 = 0.008$ (W/m <sup>2</sup> K)

# Commercial Cylinder Quick Guide

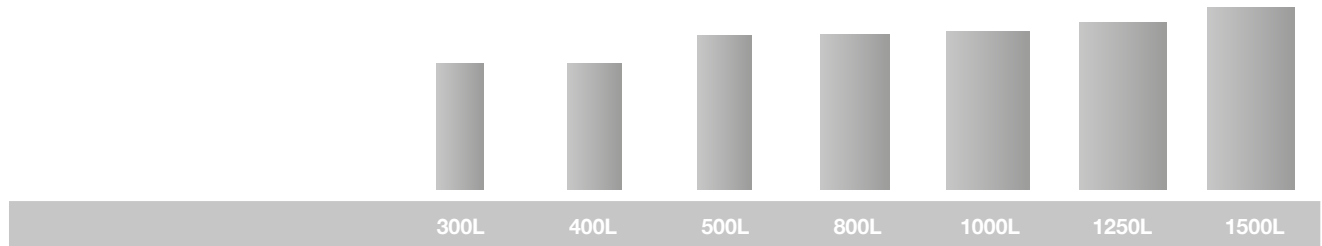

Commercial 3 & 6 bar models	Multi Energy	300L	400L	500L	800L	1000L	1250L	1500L
	Indirect	<input type="checkbox"/>	<input type="checkbox"/>	<input type="checkbox"/>	<input type="checkbox"/>	<input type="checkbox"/>	<input type="checkbox"/>	<input type="checkbox"/>
	Solar	<input type="checkbox"/>	<input type="checkbox"/>	<input type="checkbox"/>	<input type="checkbox"/>	<input type="checkbox"/>	<input type="checkbox"/>	<input type="checkbox"/>

All Cylinders - 3 & 6bar	300	400	500	800	1000	1250	1500
Diameter (mm)	620	710	710	920	1100	1150	1150
Height (mm)	1670	1670	2030	2050	2170	2200	2400
Hot And Cold Connections BSP F	1.5"	1.5"	1.5"	2.0"	2.0"	2.0"	2.0"
Coil Conn. (+for the solar coil) BSP F	1.5"	1.5"	1.5"	1.5"	1.5"	1.5"	1.5"
Secondary Return BSP F	1.25"	1.25"	1.25"	1.25"	1.25"	1.5"	1.5"
Max. Op. Pressure - 3/6 bar kit (bar)	6 / 10	6 / 10	6 / 10	6 / 10	6 / 10	6 / 10	6 / 10
T&P Setting 3/6 bar kit (bar)	7 / 10	7 / 10	7 / 10	7 / 10	7 / 10	7 / 10	7 / 10
T&P Size - Multi Energy / Indirect+Solar	1.0" / 0.75"	1.0" / 0.75"	1.0" / 0.75"	1.0" / 0.75"	1.25" / 0.75"	1.25" / 1.25"	1.25" / 1.25"
Cold W. Safety Devices - PRV, ERV, Chk Vlv	1.0" (one piece)		1.25" (multi piece)		1.5" (multi piece)		
Exp. Relief Valve Setting - 3/6 bar kit (bar)	6 / 8	6 / 8	6 / 8	6 / 8	6 / 8	6 / 8	6 / 8
2-port Mot. Valve (Indirect&Solar Only)	28mm	28mm	28mm	28mm	1.25"	1.5"	1.5"
2-port Mot. Valve Conn. (Ind & Sol Only)	Compression nut and olive				Pipe union conn. nut and tail piece		
Expansion Vessel Size - 3/6 bar kit (ltr)	24 / 35	35 / 50	50 / 80	80 / 100	100 / 150	150 / 200	150 / 200
Tundish	1.25"	1.25"	1.25"	1.25"	1.5"	1.5"	1.5"
ErP Energy Efficiency Class	C	C	C	C	C	C	C
Standing Loss (W)	92	102	115	121	124	135	160

Multi Energy Only	300	400	500	800	1000	1250	1500
Titanium Imm. - Fact. Fitted As Std.	3 x 6kW	3 x 6kW	3 x 6kW	3 x 6kW	2 x 6kW	2 x 6kW	2 x 6kW
No. Of Imm Heater Bosses In Total	4x Screw				3x Screw + 1x Flange		
Maximum Energy Input Permitted (kW)	48	48	48	48	78	78	78
Imm. Heaters - Opt. Higher Rated Elements	See page 71 for further details						
Inspection Flange	Optional - CANNOT be used for flanged imm. heaters				Supplied as std - CAN be used for fl. imm.		
Heat Up Time ΔT 50°C	Reheat time in mins = Litres x 3.2 / kW installed						

Indirect Only	300	400	500	800	1000	1250	1500
Titanium Imm. - Fact. Fitted As Std.	2 x 3kW	2 x 3kW	2 x 3kW	2 x 3kW	2 x 3kW	2 x 3kW	2 x 3kW
Coil Surface Area (m <sup>2</sup> )	1.54	1.97	1.97	2.86	2.86	4.73	4.73
Coil Diameter (mm)	32	32	32	38	38	38	38
Coil Rating @60L/min 80°C (kW)	49	57	57	73	73	98	98
Coil - Maximum Pressure (bar)	6	6	6	6	6	6	6
Inspection Flange	Optional - for inspection only - CANNOT be used with flanged immersion heaters						

Solar Only	300	400	500	800	1000	1250	1500
Titanium Imm. - Fact. Fitted As Std.	2 x 3kW	2 x 3kW	2 x 3kW	2 x 3kW	2 x 3kW	2 x 3kW	2 x 3kW
Primary Couil Surface Area (m <sup>2</sup> )	1.21	1.21	1.21	2.86	2.86	4	4
Prim. Coil Rating @ 60L/m 80°C (kW)	46	46	46	73	73	95	95
Coils (Prim & Solar) - Max. Pressure (bar)	6	6	6	6	6	6	6
Dedicated Solar Volume (ltr)	113.1	153.3	197.9	307.9	460.8	499.0	483.0
Solar Coil Surface Area (m <sup>2</sup> )	1.1	1.1	1.1	2.0	2.0	2.5	2.5
Coil Diameter (Both Coils)	32	32	32	38	38	38	38
Solar Coil Rating @ 60L/m (kW)	43	43	43	57	57	68	68
Inspection Flange	Optional - for inspection only - CANNOT be used with flanged immersion heaters						

# Immersion Allocation

300 - 800 Ltr

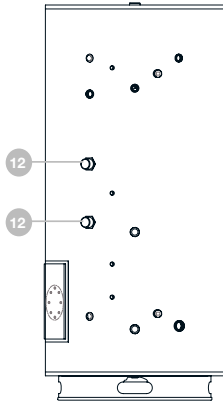

1000 - 1500 Ltr

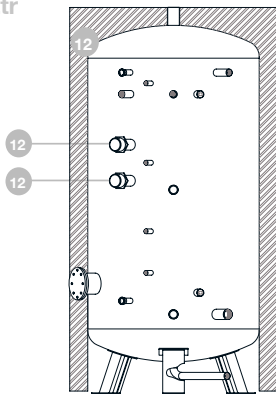

300 - 800 Ltr

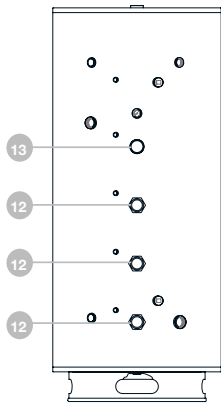

1000-1500 Ltr

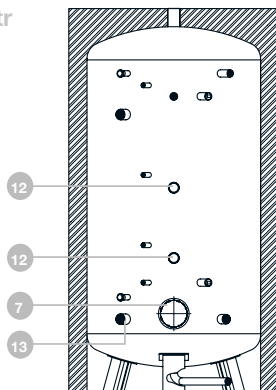

## Indirect & Solar Models

Indirect	300	400	500	800	1000	1250	1500
6 bar	•	•	•	•	•	•	•
3 bar	•	•	•	•	•	•	•
No Of Immersions (230V)	2x3kW	2x3kW	2x3kW	2x3kW	2x3kW	2x3kW	2x3kW
Inspection Flange (not Imm.)	Opt.	Opt.	Opt.	Opt.	Opt.	Opt.	Opt.

Solar	300	400	500	800	1000	1250	1500
6 bar	•	•	•	•	•	•	•
3 bar	•	•	•	•	•	•	•
No Of 3kW 230V Imm.	2	2	2	2	2	2	2
Insp. Flange (not Imm.)	Opt.	Opt.	Opt.	Opt.	Opt.	Opt.	Opt.

- Note:
- Heating elements are factory fitted
  - Inspection hatches need to be ordered separately
  - Inspection flanges cannot be used for immersion heaters on Indirect and Solar models

### Immersion

Screw Type - Factory Fitted

## Multi Energy Models

Multi Energy	300	400	500	800	1000	1250	1500
6 bar	•	•	•	•	•	•	•
3 bar	•	•	•	•	•	•	•
Screw Type Imm. Fact. Fitted	3x6kW	3x6kW	3x6kW	3x6kW	2x6kW	2x6kW	2x6kW
Screw Type Imm. Opt.	1	1	1	1	2	2	2
Immersion Flange	Opt.	Opt.	Opt.	Opt.	Std.	Std.	Std.

Multi Energy (Max. kW)	300	400	500	800	1000	1250	1500
Screw Imm. - Bottom	12	12	12	12	54	54	54
Screw Imm. - Lower Mid	12	12	12	12	Either Flange or Screw		
Screw Imm. - Upper Mid	12	12	12	12	12	12	12
Screw Imm. - Top	12	12	12	12	12	12	12
Max. Total kW Input	48	48	48	48	78	78	78

- Note:
- Optional heating elements are not factory fitted
  - Required Immersions must be ordered at the same time as ordering the cylinder
  - Bottom screw immersion and flange imm. cannot be used together on 1000-1500L units
  - See page 78 for immersion heater ordering codes

**! Inspection port must be ordered separately. Only standard on Multi Energy cylinders 1000L and over capacity.**

### Immersion

- 7 Flange Type
- 12 Screw Type - Factory Fitted
- 13 Screw Type - Blanked

## Indirect Commercial



Performance	300	400	500	800	1000	1250	1500
Inspection Flange	Optional	Optional	Optional	Optional	Optional	Optional	Optional
Heat Up Time $\Delta T$ 50°C (min)*	23	26	30	48	62	64	74
Hot Water Capacity (ltr)	283	379	485	747	1079	1201	1350
1° Re-Heat time (70% draw off) 60L/min	17	20	27	31	39	40	51
2° Re-Heat time (70% draw off) 30L/min	24	28	37	48	57	61	73
3° Re-Heat time (70% draw off) 15L/min	36	41	54	78	88	110	131
Weight Empty (kg)	82	87	104	220	230	235	267
Weight Full (kg)	365	466	589	967	1309	1436	1617
Prim. Coil Surf. Area (m <sup>2</sup> )	1.54	1.97	1.97	2.86	2.86	4.73	4.73
Prim. Coil Rating @ 60L/min (kW)	49	57	57	73	73	98	98
Prim. Coil Rating @ 30L/min (kW)	35.6	42	42	50	50	66	66
Prim. Coil Rating @ 15L/min (kW)	23	29	29	31	31	35.12	35.12
Prim. Coil Press. Drop @ 15L/min (mbar)	21	29	29	18	18	16	16
Prim. Coil Press. Drop @ 30L/min (mbar)	32	38	38	75	75	55	55
Prim. Coil Press. Drop @ 60L/min (mbar)	290	310	310	430	430	240	240
Cont. Output @ 60°C $\Delta T$ 50°C (L/hr)	685	765	765	829	829	1015	1015
Prim. Coil - Max Operating Press. (bar)	6	6	6	6	6	6	6



Connection Sizes & Safety	300	400	500	800	1000	1250	1500
Hot & Cold Conn. Ø BSP F (")	1.5	1.5	1.5	2	2	2	2
Coil Connection Ø BSP F (")	1.5	1.5	1.5	1.5	1.5	1.5	1.5
Secondary Return Ø BSP F (")	1.25	1.25	1.25	1.25	1.25	1.5	1.5
T&P Connection Ø BSP F (")	0.75	0.75	0.75	0.75	1	1	1
3 bar T&P Press. Set. (bar)	7	7	7	7	7	7	7
3 bar Exp. Relief Set. (bar)	6	6	6	6	6	6	6
6 bar T&P Press. Set. (bar)	10	10	10	10	10	10	10
6 bar Exp. Relief Set. (bar)	8	8	8	8	8	8	8

**300 - 800 Ltr**

**1000 - 1500 Ltr**

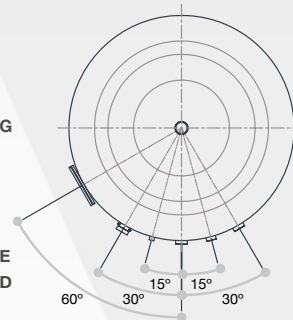
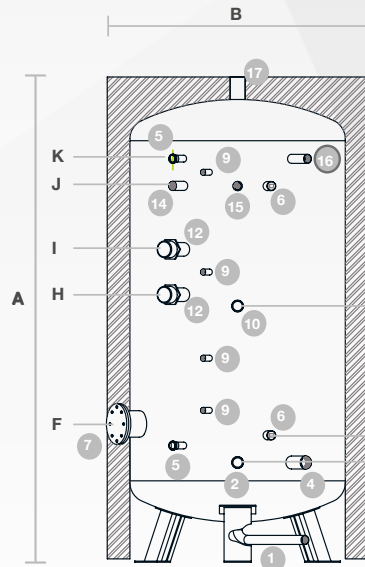
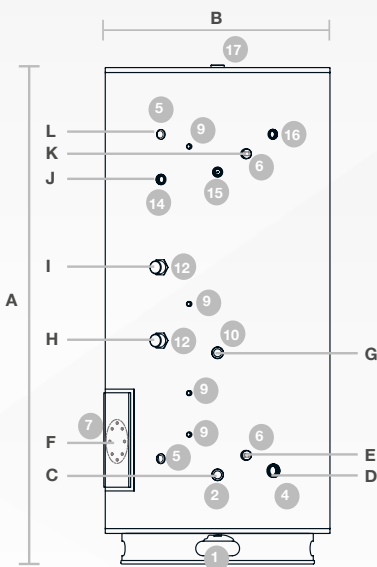

- 1 Drain
- 2 Boiler Return
- 4 Cold Water Inlet
- 5 Temperature Gauge (fact. fitted)
- 6 Heat Source F&R / D-strat (28mm)
- 7 Inspection Hatch c/w Plastic Cover (optional)
- 8 Dry Sensor Pocket
- 9 Aquastat Pocket
- 10 Boiler Flow
- 12 Titanium Immersion (fact. fitted)
- 14 Secondary Return
- 15 Pressure Gauge
- 16 T&P Relief Valve
- 17 Hot Water Draw Off

Dimensions	300	400	500	800	1000	1250	1500
Cylinder Height A (mm)	1670	1670	2030	2050	2170	2200	2400
Cylinder Diameter B (mm)	620	710	710	920	1100	1150	1150
Connection Height C (mm)	325	340	340	395	900	950	950
Connection Height D (mm)	335	350	350	415	425	410	360
Connection Height E (mm)	475	440	440	520	525	530	480
Connection Height F (mm)	500	490	490	560	580	580	530
Connection Height G (mm)	765	750	960	890	860	1010	980
Connection Height H (mm)	815	800	1010	955	930	1060	1040
Connection Height I (mm)	995	980	1200	1255	1235	1260	1260
Connection Height J (mm)	1175	1190	1550	1590	1565	1630	1830
Connection Height K (mm)	1285	1300	1660	1695	1700	1755	1950
Connection Height L (mm)	1430	1390	1750	1785	1798	-	-



Inspection port must be ordered separately. Only standard on Multi Energy cylinders 1000L and over capacity.

ErP	300	400	500	800	1000	1250	1500
Storage volume V in ltr	283	379	485	747	1079	1201	1350
Standing Loss (W)	92	102	115	121	124	135	160
Energy Efficiency Class	C	C	C	C	C	C	C

\* Primary flow rates at 30L/m are based on a flow temperature of 80°C ± 2°C Testing is carried out to BS EN12897:2006



For information on Immersion Heater options see page 71.

# Multi Energy Commercial



<b>Performance</b>		<b>300</b>	<b>400</b>	<b>500</b>	<b>800</b>	<b>1000</b>	<b>1250</b>	<b>1500</b>
Hot Water Capacity (ltr)		289.5	391	497	766	1097	1231	1410
Quantity Of Factory Fitted Immersions		3	3	3	3	2	2	2
Rating Of Factory Fitted Imm. (kW/V)		6/240	6/240	6/240	6/240	6/240	6/240	6/240
Factory Fitted Immersion Type		Titanium						
Number Of Immersion Bosses		4	4	4	4	2	2	2
Max. Allowable Power Outp. Of Imm. (kW)		48	48	48	48	78	78	78
Inspection Flange		Optional				Standard		
Heat Up Time ( $\Delta T$ 50°C)	min	53	71	89	143	*	*	*
Fact. Fitted	kW	18	18	18	18	12	12	12
Cont. Output - Fact. Fitted	L/hr	281	281	281	281	*	*	*
Heat Up Time ( $\Delta T$ 50°C)	min	21	29	37	57	49	55	64
Max. Allowed	kW	48	48	48	48	78	78	78
Cont. Output @60°C - Max. Allowed	L/hr	826	826	826	826	1342	1342	1342
Weight Empty (kg)		71.5	72	89	186	188	191	207
Weight Full (kg)		361	463	586	952	1285	1422	1617



For information on Immersion Heater options see page 71.

\* Based on selected immersion capacity at the time of ordering

<b>Connection Sizes &amp; Safety</b>		<b>300</b>	<b>400</b>	<b>500</b>	<b>800</b>	<b>1000</b>	<b>1250</b>	<b>1500</b>
Hot & Cold Conn. Ø BSP F (")		1.5	1.5	1.5	2	2	2	2
Coil Connection Ø BSP F (")		1.5	1.5	1.5	1.5	1.5	1.5	1.5
Secondary Return Ø BSP F (")		1.25	1.25	1.25	1.25	1.25	1.5	1.5
T&P Connection Ø BSP F (")		1	1	1	1	1.25	1.25	1.25
3 bar	T&P Press. Set. (bar)	7	7	7	7	7	7	7
	Exp. Relief Set. (bar)	6	6	6	6	6	6	6
6 bar	T&P Press. Set. (bar)	10	10	10	10	10	10	10
	Exp. Relief Set. (bar)	8	8	8	8	8	8	8

**300 - 800 Ltr**

**1000 - 1500 Ltr**

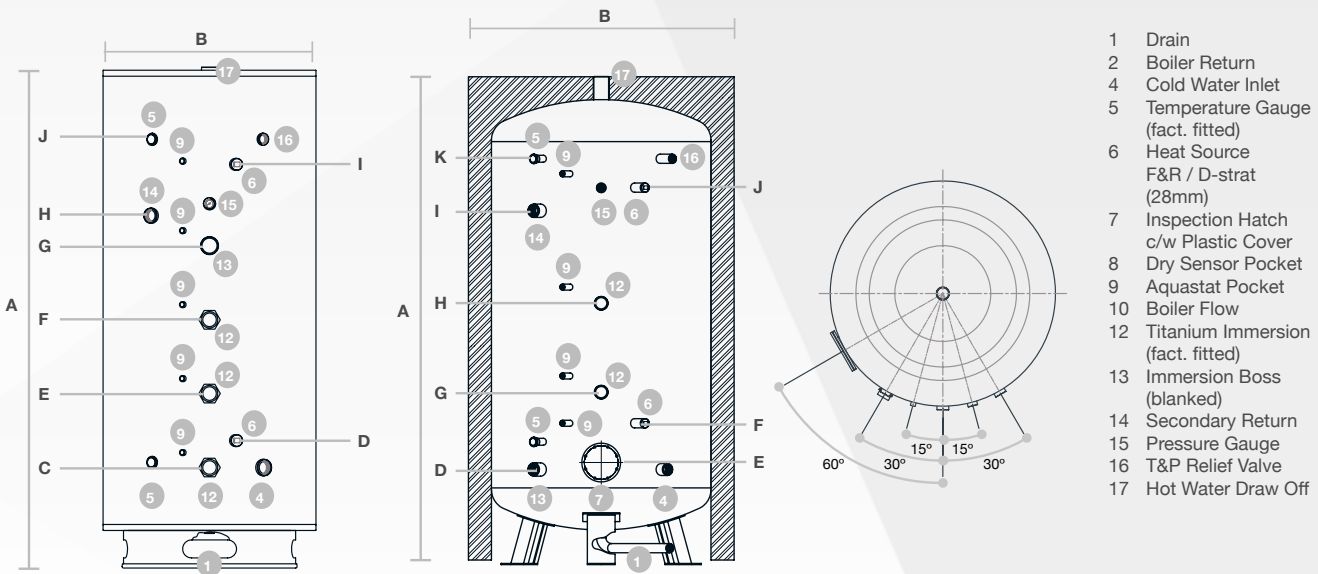

- 1 Drain
- 2 Boiler Return
- 4 Cold Water Inlet
- 5 Temperature Gauge (fact. fitted)
- 6 Heat Source F&R / D-strat (28mm)
- 7 Inspection Hatch c/w Plastic Cover
- 8 Dry Sensor Pocket
- 9 Aquastat Pocket
- 10 Boiler Flow
- 12 Titanium Immersion (fact. fitted)
- 13 Immersion Boss (blanked)
- 14 Secondary Return
- 15 Pressure Gauge
- 16 T&P Relief Valve
- 17 Hot Water Draw Off

<b>Dimensions</b>	<b>300</b>	<b>400</b>	<b>500</b>	<b>800</b>	<b>1000</b>	<b>1250</b>	<b>1500</b>
Cylinder Height A (mm)	1670	1670	2030	2050	2170	2200	2400
Cylinder Diameter B (mm)	620	710	710	920	1100	1150	1150
Connection Height C (mm)	335	350	350	445	900	950	950
Connection Height D (mm)	425	440	440	570	515	410	410
Connection Height E (mm)	580	590	665	760	625	440	440
Connection Height F (mm)	830	830	975	1070	845	550	550
Connection Height G (mm)	1075	1090	1290	1385	1215	745	745
Connection Height H (mm)	1175	1190	1550	1640	1615	1130	1255
Connection Height I (mm)	1350	1300	1660	1745	1750	1530	1780
Connection Height J (mm)	1430	1390	1750	1845	1850	1630	1880
Connection Height K (mm)	-	-	-	-	-	1755	2005



Inspection port must be ordered separately. Only standard on Multi Energy cylinders 1000L and over capacity.

<b>ErP</b>	<b>300</b>	<b>400</b>	<b>500</b>	<b>800</b>	<b>1000</b>	<b>1250</b>	<b>1500</b>
Storage volume V in ltr	289.5	391	497	766	1097	1231	1410
Standing Loss (W)	92	102	115	121	124	135	160
Energy Efficiency Class	C	C	C	C	C	C	C

## Solar Commercial



Performance	300	400	500	800	1000	1250	1500
Hot Water Capacity (ltr)	278.5	377	483	732	1063	1185	1350
Heat Up Time ( $\Delta T$ 50°C)	35	46	58	71	89	96	115
1° Re-Heat time (70% draw off) 60L/min	11	15	21	28	34	38	41
1° Re-Heat time (70% draw off) 30L/min	16	21	29	40	48	52	54
1° Re-Heat time (70% draw off) 15L/min	24	38	47	71	81	90	104
Weight Empty (kg)	88	89	105.5	240	250	268	293
Weight Full (kg)	366.5	466	588	972	1313	1453	1643
Prim. Coil Surf. Area (m <sup>2</sup> )	1.21	1.21	1.21	2.86	2.86	4.00	4.00
Prim. Coil Rating @ 60L/min (kW)	46	46	46	73	73	95	95
Prim. Coil Rating @ 30L/min (kW)	36.72	36.72	36.72	50	50	54.67	54.67
Prim. Coil Rating @ 15L/min (kW)	21	21	21	31	31	34	34
Prim. Coil Press. Drop @ 15L/min (mbar)	19	19	19	16	16	26	26
Prim. Coil Press. Drop @ 30L/min (mbar)	29	29	29	65	65	75	75
Prim. Coil Press. Drop @ 60L/min (mbar)	245	245	245	335	335	350	350
Dedicated Solar Volume (ltr)	113.1	153.3	197.9	307.9	460.8	499	483
Solar Coil Surface Area (m <sup>2</sup> )	1.1	1.1	1.1	2	2	2.5	2.5
Solar Coil Rating @ 60L/min (kW)	43	43	43	57	57	68	68
Cont. Output @ 60°C $\Delta T$ 50°C (L/hr)	453	453	453	1110	1110	1282	1282



For information on Immersion Heater options see page 71.

Connection Sizes & Safety		300	400	500	800	1000	1250	1500
	Hot & Cold Conn. Ø BSP F (")	1.5	1.5	1.5	2	2	2	2
	Prim. Coil Conn. Ø BSP F (")	1.5	1.5	1.5	1.5	1.5	1.5	1.5
	Solar Coil Conn. Ø BSP F (")	1	1	1	1	1	1	1
	Secondary Return Ø BSP F (")	1.25	1.25	1.25	1.25	1.25	1.5	1.5
	T&P Connection Ø BSP F (")	0.75	0.75	0.75	0.75	0.75	1	1
3 bar	T&P Press. Set. (bar)	7	7	7	7	7	7	7
	Exp. Relief Set. (bar)	6	6	6	6	6	6	6
6 bar	T&P Press. Set. (bar)	10	10	10	10	10	10	10
	Exp. Relief Set. (bar)	8	8	8	8	8	8	8

**300 - 800 Ltr**

**1000 - 1500 Ltr**

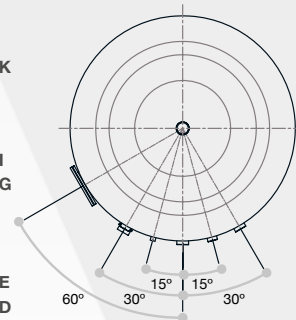
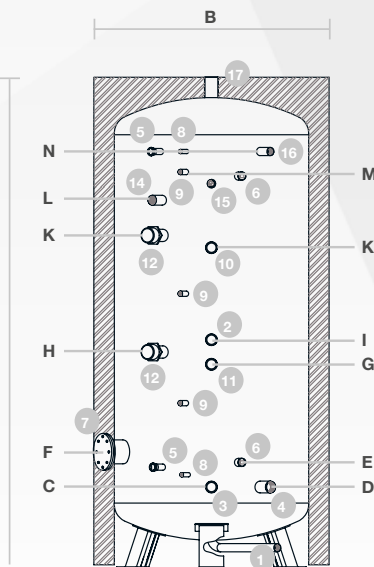
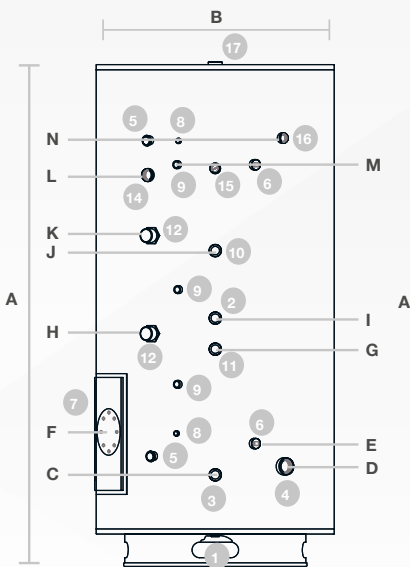

- 1 Drain
- 2 Boiler Return
- 3 Solar Return
- 4 Cold Water Inlet
- 5 Temperature Gauge (fact. fitted)
- 6 Heat Source F&R / D-strat (28mm)
- 7 Inspection Hatch c/w Plastic Cover (optional)
- 8 Dry Sensor Pocket
- 9 Aquastat Pocket
- 10 Boiler Flow
- 11 Solar Flow
- 12 Titanium Immersion (fact. fitted)
- 14 Secondary Return
- 15 Pressure Gauge
- 16 T&P Relief Valve
- 17 Hot Water Draw Off

Dimensions	300	400	500	800	1000	1250	1500
Cylinder Height A (mm)	1670	1670	2030	2050	2170	2200	2400
Cylinder Diameter B (mm)	620	710	710	920	1100	1150	1150
Connection Height C (mm)	335	350	350	395	900	950	950
Connection Height D (mm)	335	350	350	420	425	410	410
Connection Height E (mm)	425	440	440	515	525	530	530
Connection Height F (mm)	475	490	490	560	580	580	580
Connection Height G (mm)	665	670	800	845	850	820	1050
Connection Height H (mm)	715	720	860	905	910	880	1110
Connection Height I (mm)	765	770	920	965	970	940	1170
Connection Height J (mm)	1145	1095	1300	1345	1350	1320	1550
Connection Height K (mm)	1195	1145	1360	1405	1410	1380	1610
Connection Height L (mm)	1305	1245	1550	1505	1560	1580	1810
Connection Height M (mm)	1340	1300	1660	1550	1700	1630	1890
Connection Height N (mm)	1430	1390	1730	1655	1800	1750	2010



Inspection port must be ordered separately. Only standard on Multi Energy cylinders 1000L and over capacity.

ErP	300	400	500	800	1000	1250	1500
Storage volume V in ltr	278.5	377	483	732	1063	1185	1350
Standing Loss (W)	92	102	115	121	124	135	160
Energy Efficiency Class	C	C	C	C	C	C	C

## Ordering Guide - Commercial

### Commercial Indirect - 3bar

Product	300	400	500	800	1000	1250	1500
Cylinder Height (A, mm)	1670	1670	2030	2050	2090	2200	2400
Cylinder Diameter (B, mm)	620	710	710	920	1100	1150	1150
Weight Empty (kg)	82	87	104	220	230	235	267
Weight Full (kg)	365	466	589	967	1309	1436	1617
ErP Rating	C	C	C	C	C	C	C
Cylinder Ordering Code	TCFMVI-0300NFC	TCFMVI-0400LFC	TCFMVI-0500LFC	TCFMVI-0800LFC	TCFMVI-1000LFC	TCFMVI-1250LFC	TCFMVI-1500LFC
Unvented Kit Ordering Code	Inc.	Inc.	Inc.	TYN-32-03-080L	TYN-32-03-100L	Inc.	Inc.

### Commercial Indirect - 6bar

Product	300	400	500	800	1000	1250	1500
Cylinder Height (A, mm)	1670	1670	2030	2050	2090	2200	2400
Cylinder Diameter (B, mm)	620	710	710	920	1100	1150	1150
Weight Empty (kg)	82	87	104	220	230	235	267
Weight Full (kg)	365	466	589	967	1309	1436	1617
ErP Rating	C	C	C	C	C	C	C
Cylinder Ordering Code	TCGMVI-0300NFC	TCGMVI-0400LFC	TCGMVI-0500LFC	TCGMVI-0800LFC	TCGMVI-1000LFC	TCGMVI-1250LFC	TCGMVI-1500LFC
Unvented Kit Ordering Code	Inc.	Inc.	Inc.	Inc.	Inc.	Inc.	Inc.

### Commercial Multi Energy - 3bar

Product	300	400	500	800	1000	1250	1500
Cylinder Height (A, mm)	1670	1670	2030	2050	2090	2200	2400
Cylinder Diameter (B, mm)	620	710	710	920	1100	1150	1150
Weight Empty (kg)	71.5	72	89	186	188	191	207
Weight Full (kg)	361	463	586	952	1285	1422	1617
ErP Rating	C	C	C	C	C	C	C
Cylinder Ordering Code	TCFMVD-0300LFD	TCFMVD-0400LFD	TCFMVD-0500LFD	TCFMVD-0800LFD	TCFMVD-1000LFD	TCFMVD-1250LFD	TCFMVD-1500LFD
Unvented Kit Ordering Code	Inc.	Inc.	Inc.	TYD-32-03-080L	TYD-32-03-100L	Inc.	Inc.

### Commercial Multi Energy - 6bar

Product	300	400	500	800	1000	1250	1500
Cylinder Height (A, mm)	1670	1670	2030	2050	2090	2200	2400
Cylinder Diameter (B, mm)	620	710	710	920	1100	1150	1150
Weight Empty (kg)	71.5	72	89	186	188	191	207
Weight Full (kg)	361	463	586	952	1285	1422	1617
ErP Rating	C	C	C	C	C	C	C
Cylinder Ordering Code	TCGMVD-0300NFD	TCGMVD-0400LFD	TCGMVD-0500LFD	TCGMVD-0800LFD	TCGMVD-1000LFD	TCGMVD-1250LFD	TCGMVD-1500LFD
Unvented Kit Ordering Code	Inc.	Inc.	Inc.	Inc.	Inc.	Inc.	Inc.

## Commercial Solar - 3bar

Product	300	400	500	800	1000	1250	1500
Cylinder Height (A, mm)	1670	1670	2030	2050	2090	-	-
Cylinder Diameter (B, mm)	620	710	710	920	1020	-	-
Weight Empty (kg)	88	89	105.5	240	250	-	-
Weight Full (kg)	366.5	466	588	972	1313	-	-
ErP Rating	C	C	C	C	C	-	-
Cylinder Ordering Code	TCFMVS-0300NFC	TCFMVS-0400LFC	TCFMVS-0500LFC	TCFMVS-0800LFC	TCFMVS-1000LFC	-	-
Unvented Kit Ordering Code	Inc.	Inc.	Inc.	Inc.	Inc.	-	-

## Commercial Solar - 6bar

Product	300	400	500	800	1000	1250	1500
Cylinder Height (A, mm)	1670	1670	2030	2050	2090	-	-
Cylinder Diameter (B, mm)	620	710	710	920	1020	-	-
Weight Empty (kg)	88	89	105.5	240	250	-	-
Weight Full (kg)	366.5	466	588	972	1313	-	-
ErP Rating	C	C	C	C	C	-	-
Cylinder Ordering Code	TCGMVS-0300NFC	TCGMVS-0400LFC	TCGMVS-0500LFC	TCGMVS-0800LFC	TCGMVS-1000LFC	-	-
Unvented Kit Ordering Code	Inc.	Inc.	Inc.	Inc.	Inc.	-	-

Option Of Inspection Flange Available on Request - Not Included As Standard  
Custom Specification Models Available

## Immersion Heaters

Description	Ordering Code
3KW 1PH Incoly Imm. Screw Dom	TI-I-L-14-03-1
3KW 1PH Smart Incoly Imm. Screw	TI-I-S-14-03-1
6KW 1PH Incoly Imm. Screw	TI-I-L-14-06-1
6KW 3PH Incoly Imm. Screw	TI-I-L-14-06-3
9KW 1PH Incoly Imm. Screw	TI-I-L-14-09-1
9KW 3PH Incoly Imm. Screw	TI-I-L-16-09-3
12KW 3PH Incoly Imm. Screw	TI-I-L-16-12-3
18KW 3PH Incoly Imm. Flange	TI-I-M-36-18-3
24KW 3PH Incoly Imm. Flange	TI-I-M-36-24-3
30KW 3PH Incoly Imm. Flange	TI-I-M-36-30-3
36KW 3PH Incoly Imm. Flange	TI-I-M-36-36-3
40KW 3PH Incoly Imm. Flange	TI-I-M-36-40-3
45KW 3PH Incoly Imm. Flange	TI-I-M-36-45-3
54KW 3PH Incoly Imm. Flange	TI-I-M-36-54-3
3Kw 1PH Titanium Imm. Screw	TI-T-L-14-03-1
6Kw 1PH Titanium Imm. Screw	TI-T-L-16-06-1
6Kw 3PH Titanium Imm. Screw	TI-T-L-16-06-3
9Kw 3PH Titanium Imm. Screw	TI-T-L-16-09-3
12Kw 3PH Titanium Imm. Screw	TI-T-L-18-12-3

# Water Heaters - Under/Over Sink

## Why Is It Good?

The SmarTherm Water Heaters provide stored hot water from a mains pressurised water supply. The SmarTherm unvented water storage heater comes complete with a pressure relief device for inline installation.

- Hot water to up to four basins
- Balanced supply of hot and cold water
- Heat loss minimisation and energy savings from short pipe runs and superior insulation
- Water outlet via existing tap or mixer
- Adjustable thermostat to 70°C with eco and frost protection settings
- Compact shape for undersink mounting
- Remote siting possible
- 2 kW loading
- 10 and 15 litre capacity models
- 6bar expansion relief valve
- Push button power on/off and neon 'heating' indicator



Water heaters with electrical-mechanical pop-up operation



Model	10l Under	15L Under	10L Over	15L Over
<b>Product Code</b>	OJ-00000U102KW	OJ-00000U152KW	OJ-00000O102KW	OJ-00000O152KW
<b>DI-Electric Fittings</b>	2	2	2	2
<b>3-Pin Plug</b>	1	1	1	1
<b>Temperature Lock</b>	1	1		
<b>1/2" Pressure Relief</b>	1	1	1	1
<b>Energy Efficiency (%)</b>	29	28	29	28

## Using A Set Of Expansion Controls

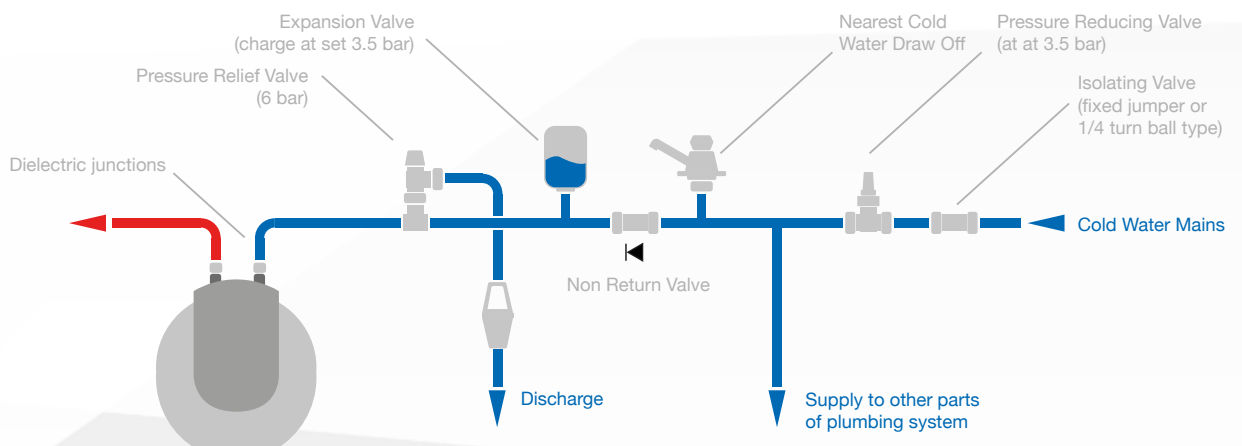



# Water Heaters - Wall Hung

Horizontal Models	80L	100L	120L
Capacity (L)	80	100	120
Length (mm)	930	1090	1250
Diameter (mm)	495	495	495
Element Rating (@230V)	3kW	3kW	3kW
Weight Empty (kg)	28	32	36
Weight Full (kg)	107	133	154
Rated Pressure (bar)	6	6	6
Connection Size	3/4"	3/4"	3/4"
Pressure Tested (bar)	12	12	12
Heat Up Time (mins)*	86	107	130
Recovery Time (mins)**	60	75	91
Factory Fitted Temp. Guage	Yes	Yes	Yes
Factory Fitted T&P relief Valve	Yes	Yes	Yes
ErP Rating	C	C	C
Product Code	OJ000M-H0803KW	OJ000M-H1003KW	OJ000M-H1203KW



\* Heat up times are based on heating from 20°C through 45°C  
 \*\* Recovery times are based on heating 70% of capacity through 45°C

Vertical Models	80L	100L	120L	30L	50L
				Copper versions	
Capacity (L)	80	100	120	30	50
Height (mm)	860	1020	1180	580	830
Diameter (mm)	495	495	495	380	380
Element Rating (@230V)	3kW	3kW	3kW	2kW	2kW
Weight Empty (kg)	28	32	36	16	22
Weight Full (kg)	107	133	154	46	72
Rated Pressure (bar)	6	6	6	6	6
Connection Size	3/4"	3/4"	3/4"	3/4"	3/4"
Pressure Tested (bar)	12	12	12	12	12
Heat Up Time (mins)*	86	107	130	48	80
Recovery Time (mins)**	60	75	91	34	56
Factory Fitted Temp. Guage	Yes	Yes	Yes	Yes	Yes
Factory Fitted T&P relief Valve	Yes	Yes	Yes	Yes	Yes
ErP Rating	C	C	C	C	C
Product Code	OJ000M-H0803KW	OJ000M-H1003KW	OJ000M-H1203KW	OJ-000M-V0303KW	OJ-000M-V0503KW



\* Heat up times are based on heating from 20°C through 45°C  
 \*\* Recovery times are based on heating 70% of capacity through 45°C

# ErP as Easy as 1-2-3

ErP stands for energy related product and as of September 26th all cylinders sold by manufacturers to merchants must include an energy rating label and a technical product fiche.

This does not mean all cylinders sold by merchants to installers must have labels on them, merchants have time to flush out their stocks.

A product fiche is an additional piece of paper that must accompany the cylinder with certain information that is not included on the label. You will find this fiche in the manual for the cylinder.



## Product labels

### Indirect Cylinder label

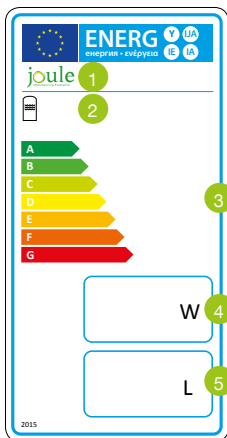

- 1 Model name
- 2 Cylinder logo donates Water Storage Label
- 3 Energy Efficiency
- 4 Heat Loss
- 5 Actual Volume

### Direct Cylinder label

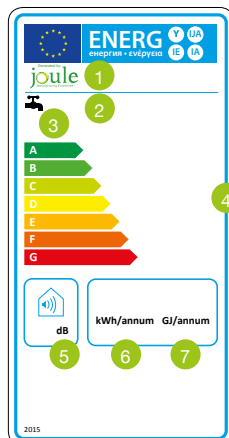

- 1 Model name
- 2 Tap logo donates Water Heater Label
- 3 Load Profile
- 4 Energy Efficiency
- 5 Rated Sound Level
- 6 Annual Energy Consumption
- 7 Annual Energy Consumption

## Package labels

### System Boiler package

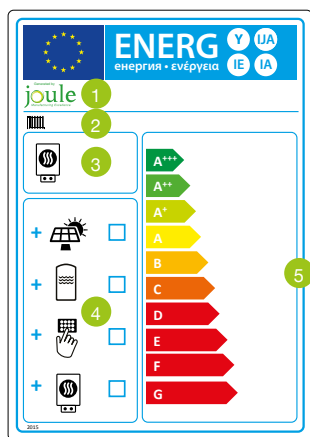

- 1 Model name
- 2 Radiator Logo donates Heating System Package Label
- 3 Efficiency details of selected boiler
- 4 Components used in the system
- 5 Energy Efficiency

### Combi Boiler package

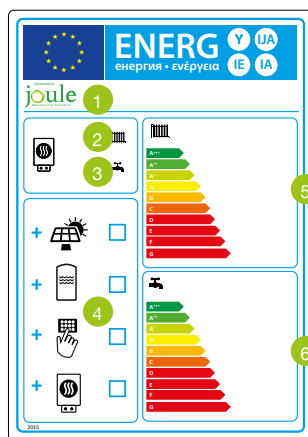

- 1 Model name
- 2 Efficiency details of selected boiler on the heating side
- 3 Efficiency details of selected boiler on the fresh water side
- 4 Components used in the system
- 5 Energy Efficiency of the system on the heating side
- 6 Energy Efficiency of the system on the hot water side

# Generating Package Label at [www.erp.jouleuk.co.uk](http://www.erp.jouleuk.co.uk)

## System Boiler Package Label

**1** Select your system boiler from the boiler tab. System boiler identified by radiator symbol only.

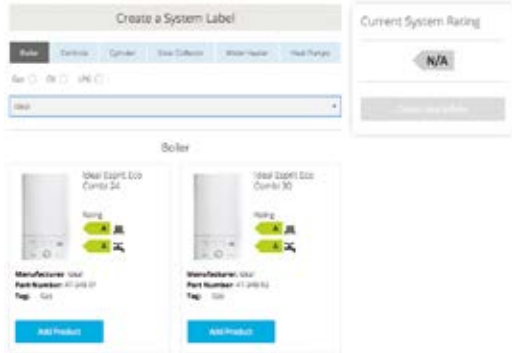

**2** Select your heating controller from the controller tab.

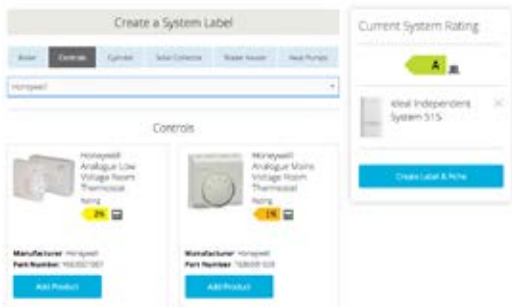

**3** Select your cylinder from the cylinder tab and then press "Create label & Fiche" on the right hand side.

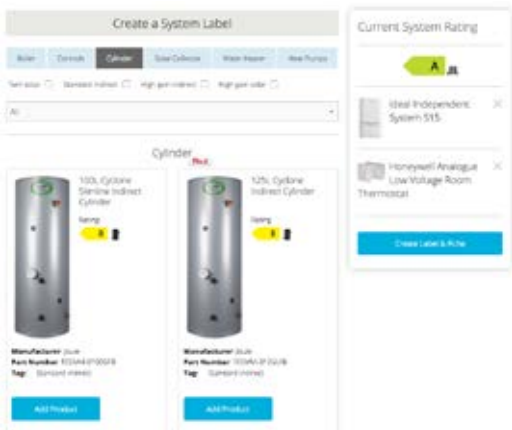

**4** Generate your label.



## Combi Boiler Package Label

**1** Select your combi boiler from the boiler tab. Combi Boiler identified by radiator and tap symbols.

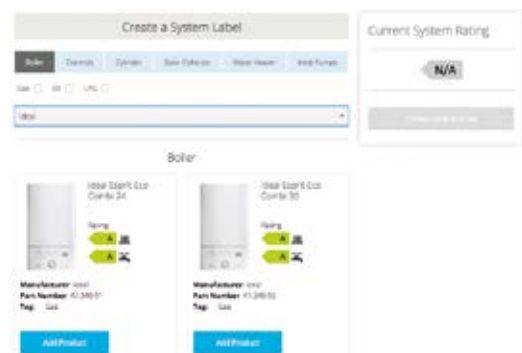

**2** Select your heating controller from the controller tab and then press "Create label & Fiche" on the right hand side.

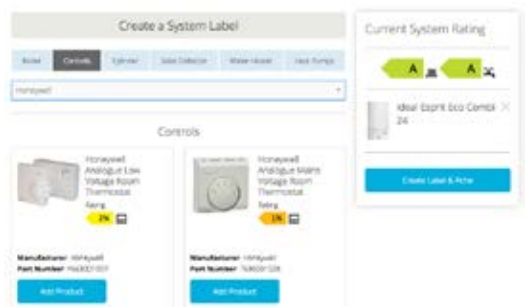

**3** Generate your label.



## Installation Guidance

### Regulations

Joule Cyclone is covered by Section G3 of the Building Regulations (England and Wales), Technical Standard P3 (Scotland) and Building Regulations P5 (Northern Ireland). All Unvented units with a capacity over 15ltr must be installed by a competent installer in accordance with these regulations.

### Mains Supply

The Cyclone unvented cylinder needs a minimum of 1.5 bar (max 10 bar) mains pressure and 20 litres a minute flow rate to ensure that the cylinder meets its minimum capabilities. Higher mains pressure and flow rates will result in a higher performance from the cylinder.

### Cylinder Siting

With no header tanks to consider, Joule Cyclone units can be sited almost anywhere in the house. Cyclone can supply outlets both above and below its location and must be fitted on a flat surface capable of holding its full weight. (Refer to installation instructions supplied with cylinder).

### Boiler Compatibility

Any appliance that is fitted with an integral control thermostat and its own energy cut-out (these include natural gas, LPG, electric and oil boilers). Solid fuel appliances such as Aga, Rayburn, etc., without full thermostatic control cannot usually be installed with an unvented unit. Please consult the Cyclone installation guide for further information.

### Secondary Return Connection

As standard all Cyclone Stainless Unvented come with a secondary return connection.

### Wiring

All electrical wiring should be carried out by a competent electrician and be in accordance with the control scheme being used and the latest IEE regulations. The controls provided with the Cyclone will ensure the safe operation of the unit within a central heating system. The Cyclone is compatible with Y, S and S plan plus layouts. External wiring to the immersion heaters must comply with the relevant IEE wiring regulations and the circuit must be protected by a suitable fuse and a double pole isolating switch.

### Connection Sizes

Cold Inlet	22mm Compression
Hot Outlet	22mm Compression
Coil Connections	22mm Compression
Safety Valves	15mm Compression Outlet
Inlet Control Set	22mm Compression Inlet and Outlet
Tundish	15mm Compression Inlet 22mm Compression Outlet

# Cyclone Specification Summary

## Materials

Internal cylinder - Duplex Stainless Steel.  
 HE Coil - 22mm Stainless Steel.  
 Bosses - Stainless Steel.

Totally insulated with 100% CFC-Free (ODP zero) polyurethane to minimise heat loss (50mm thick).

Grey powder coated metallic colour, corrosion resistant, Zintec stainless steel case work.

## Control Settings

- Inlet control valve (3 bar).
- Expansion pressure relief (6 bar).
- Temperature (90°C) and pressure relief valve (7 bar).
- Dual thermostat high limit (85°C).
- Immersion heater high limit (85°C).

## Immersion Heater

- 13/4" BSP, long life incoloy sheathed low noise element.
- Long life thermostat pocket.
- Element rating 3kW at 240 A/C.

## Approvals

- KIWA approved to the water regulations.
- Approved to building regulations G3 & L.
- Components are CE compliant.

## Expansion Vessel Sizing Guide

Capacity (ltr)	12	18	24	35	50
60 - 150	☑				
180 - 250		☑			
300 - 400			☑		
450 - 550				☑	
600					☑

## Guarantee Terms Overview

The Joule stainless steel inner vessel on the Cyclone range of products carries a fully transferable 25 year guarantee applicable from the date of purchase. The guarantee covers material defect or manufacturing faults in domestic use only, of products up to the capacity of 300 litres. Please refer to installation guide and Joule UK website for guarantee terms for calorifiers and non-domestic installations.

All components supplied with the Cyclone cylinder are guaranteed against material defects or manufacturing defects faults for two years from date of purchase.

Full details of guarantee terms, conditions and exclusions can be found on the Joule UK website and in the installation guide which is provided with the cylinder.

## Connecting Units

### Using Joule Cyclone units in Parallel

For situations when very high flow rates or larger volumes of hot water storage are needed, units of two or more can be linked in parallel.

When connecting two units in parallel, individual cold feeds are taken to each cylinder and then hot draw offs are connected together. Subject to the size of the incoming cold mains the flow rate available effectively doubles.

The need for this piping situation will arise according to the demand for hot water which will vary considerably between types of buildings and activities taking place there.



### Using Joule Cyclone units in Series

A popular option is, instead of having one large cylinder, to have two small cylinders installed, as a possible solution to limited space in a cupboard.

The method of installing cylinders in series is so that the cold mains feeds the first cylinder, and the hot draw off from the first cylinder provides the feed for the second tank. The second tanks hot draw off then provides the hot supply for the property.

The supplied combination valve will be installed on the mains inlet to the first cylinder and this is also where expansion vessel for both cylinders are connected.



## Selection Guide

### Domestic

Hot Water Demand	Bed-rooms	Indirect	Direct
1 Standard Bath or Shower	Bedsit / 1	60/90	150
	2-3	120	180
	3-4	150	210
1 Standard Bath	2-3	120	180
	3-4	150	210
1 Standard Bath and En-Suite	2-3	150	210
	3-4	150	210
	4-5	180	250
2 Standard Baths	2-3	180	210
	3-4	180	210
	4-5	210	250
3 Bathrooms	3-4	250	300
	4-5	250	300
	5-6	300	300

### Commercial

Hot Water Demand	Indirect Domestic	Indirect Calorifier
<b>Large House</b> 6 Bed / 4 Bathrooms	2 x 210	1 x 450
<b>Hotel / Hostel</b> Bed / 4 Bathrooms	2 x 300	1 x 600
<b>Hotel / Hostel</b> 8 Bed / 8 Bathrooms	3 x 210	2 x 350
<b>Sports Club</b> 25 people / 4 showers	2 x 300	1 x 600
<b>Leisure Centre</b> 25 people / 6 showers	3 x 210	2 x 350
<b>Shared Accommodation</b> 25 people / 3 Bathrooms	3 x 300	2 x 450
<b>Shared Accommodation</b> 60 Beds/10 Bathrooms	5 x 300	3 x 500

**7**  
**YEAR**  
WARRANTY

The innovative Smartplumb by Joule is a cylinder and buffer combined fully pre-plumbed, wired and programmed. The cylinder has the smallest footprint of any product of its type and built of industry leading components only.

Samsung's new generation heat pumps are smartphone compatible and benefit from remote monitoring for better service.



**LOW NOISE  
LEVEL**



**BEST IN CLASS  
EFFICIENCY**



**ECO DESIGN  
CERTIFIED**



**COMPATIBLE WITH OTHER HEAT  
SOURCES**

#### JOULE IE

mail Kylemore Park West, Ballyfermot, Dublin 10  
tel +353 (1) 623 7080  
fax +353 (1) 626 9337  
eml info@joule.ie  
web www.joule.ie

#### JOULE UK

mail Unit 17C&D Power Road, Plantation Bus. Pk.  
Bromborough, Wirral, CH62 3RN  
tel +44 (0) 1513 551 094  
fax +44 (0) 1513 568 336  
eml info@jouleuk.co.uk  
web www.jouleuk.co.uk

#### JOULE PL

mail 23-200 Kraśnik, Kolejowa 10 D  
tel +48 (0) 128811171  
fax +48 (0) 814709046  
eml biuro@joule-pl.pl  
web www.joule-pl.pl